

3 Wiring diagram for each system¹

Wiring diagram for each system

Power seats related	
charging	3-2
charging	3-7
Engine related	
Stating & Ignition	3-3
Engine control (1G-E)	3-4
Engine control (1JZ-GE)	3-6
Engine control (1JZ-GTE)	3-8
Engine control (2JZ-GE)	3-10
Engine control (diesel)	3-12
Cooling fan	3-13
Fuel heater (diesel)	3-13
Chassis related	
ECT (1JZ-G E)	3-14
skyhook control suspension	
(T E M S)	3-15
ECT (1JZ-G T E)	3-16
Shift lock	3-17
Overdrive (excluding ECT)	3-17
ECT (2JZ-G E)	3-18
Shift indicator	3-19
power steering	3-19
ECT (i G T E)	3-20
Airbag	3-21
ABS (without TRC)	3-22
ABS & 4WD	3-23
ABS & TRC (JZ-GE)	3-24
Electronically controlled throttle (1, Z-GTE)	3-26
ABS & TRC (diesel)	3-30
ABS (V S C)	3-32
Body related	
outer mirror	3-25
Seat belt warping	
& tension reducer	3-31
sliding roof	3-31
Warning for forgetting to remove the key &	
Power forgetting to turn off the light	3-31
door lock	3-34
power window	3-35
front power seat	3-36

Around the instrument panel

Rear wiper & washer	3-36
Excluding built-in audio amplifier <AV integrated type>	3-37
Audio (AV lkyu type with built-in amplifier)	3-38
Horn	3-39
Audio (AV system for guests with separate amplifier)	3-40
Audio (AV integrated system except for separate amplifier)	3-42
Combination meter (analog meter)	3-44
Combination meter (digital meter)	3-46
	3-43

Lights

Headlamp (excluding 1JZ-GE S grade and 1JZ-GTE)	
1JZ-GTE	3-29
backup lamp	3-37
Conlight	3-47
Stop lamp	3-48
Tail runno	3-48
interior lamp	3-49
illumination	3-50
Figure lamp	3-51
Turn Signal & Hard	3-51
Headlamp (1JZ-GE S grade and 1JZ-GTE)	
1JZ-GTE	3-52

Air conditioning related

automatic air conditioner	3-28
Air Bill Noire	3-52

Others

Optional connector	3-21
Rear window defogger	3-34
Cigarette lighter & clock	3-35
Front window defogger &	
Mirahi Ta	3-41
Between earths	3-42
Cruise control, power	3-43
supply/earth system list	3-53



3

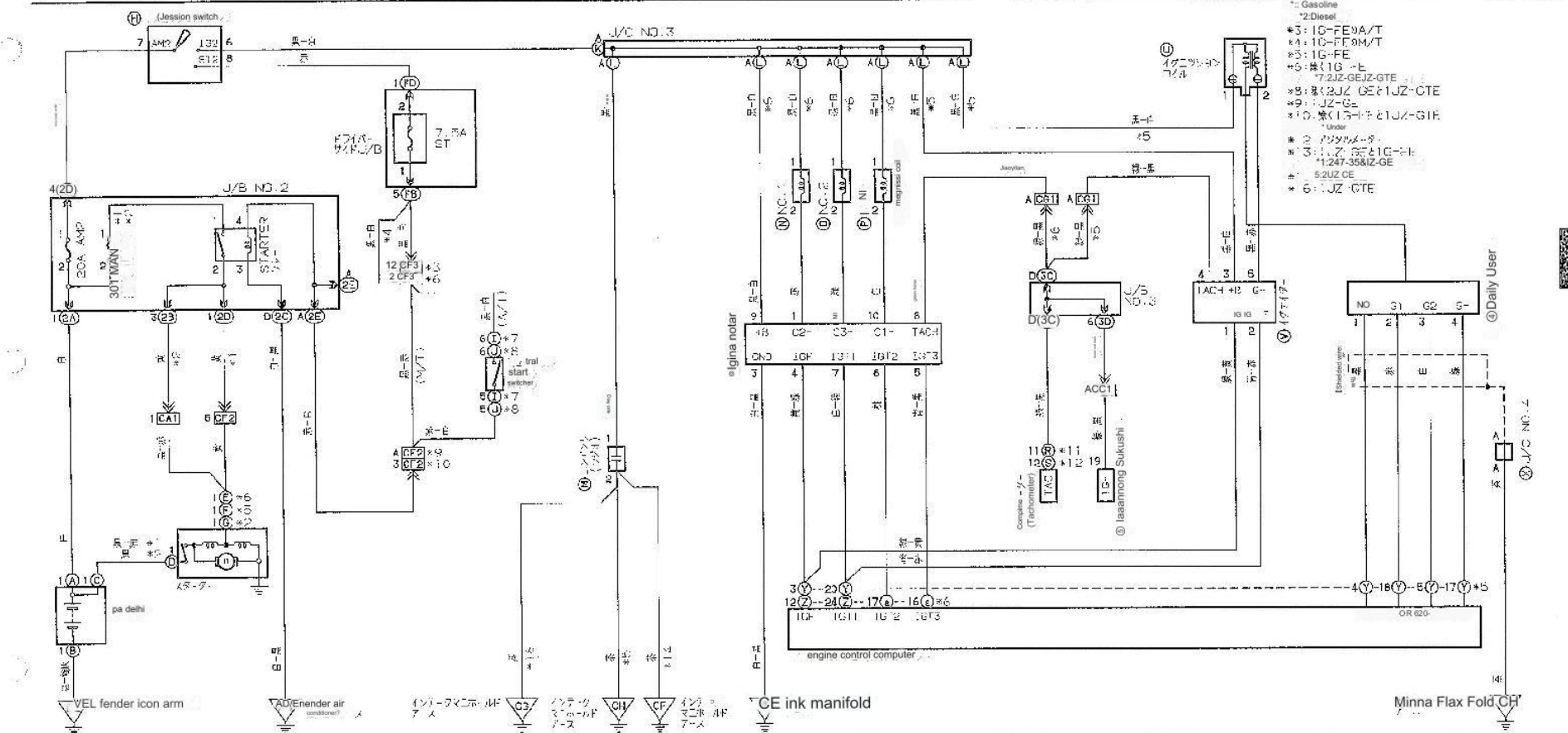

- * 1: Gasoline
- * 2: Diesel
- * 3: 1G-FE9A/T
- * 4: 1G-FE9M/T
- * 5: 1G-FE
- * 6: 1G-FE
- * 7: 2JZ-GE1JZ-GTE
- * 8: 1JZ-G2
- * 9: 1JZ-G2
- * 10: 1JZ-G2
- * 11: 1JZ-GTE
- * 12: 1JZ-GTE
- * 13: 1JZ-GTE
- * 14: 1JZ-GTE
- * 15: 1JZ-GTE
- * 16: 1JZ-GTE
- * 17: 1JZ-GTE
- * 18: 1JZ-GTE
- * 19: 1JZ-GTE
- * 20: 1JZ-GTE

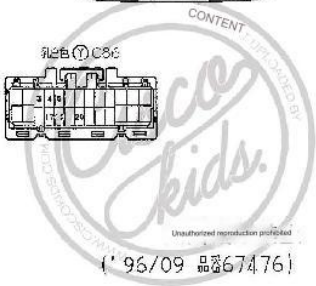
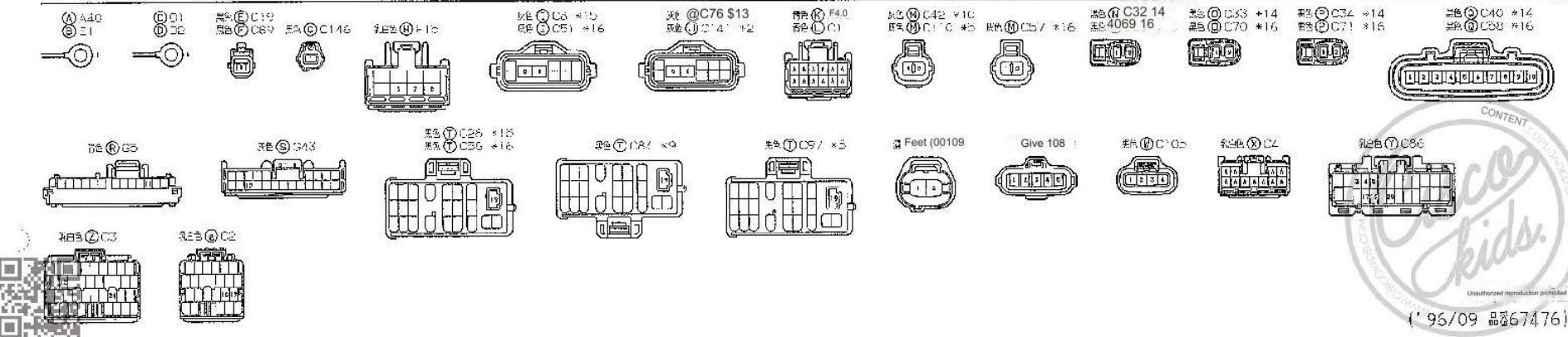

Engine control (1G-FE)

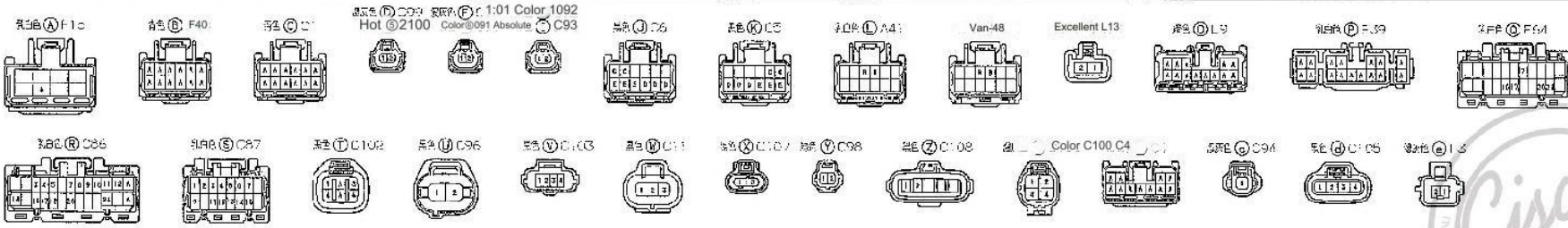
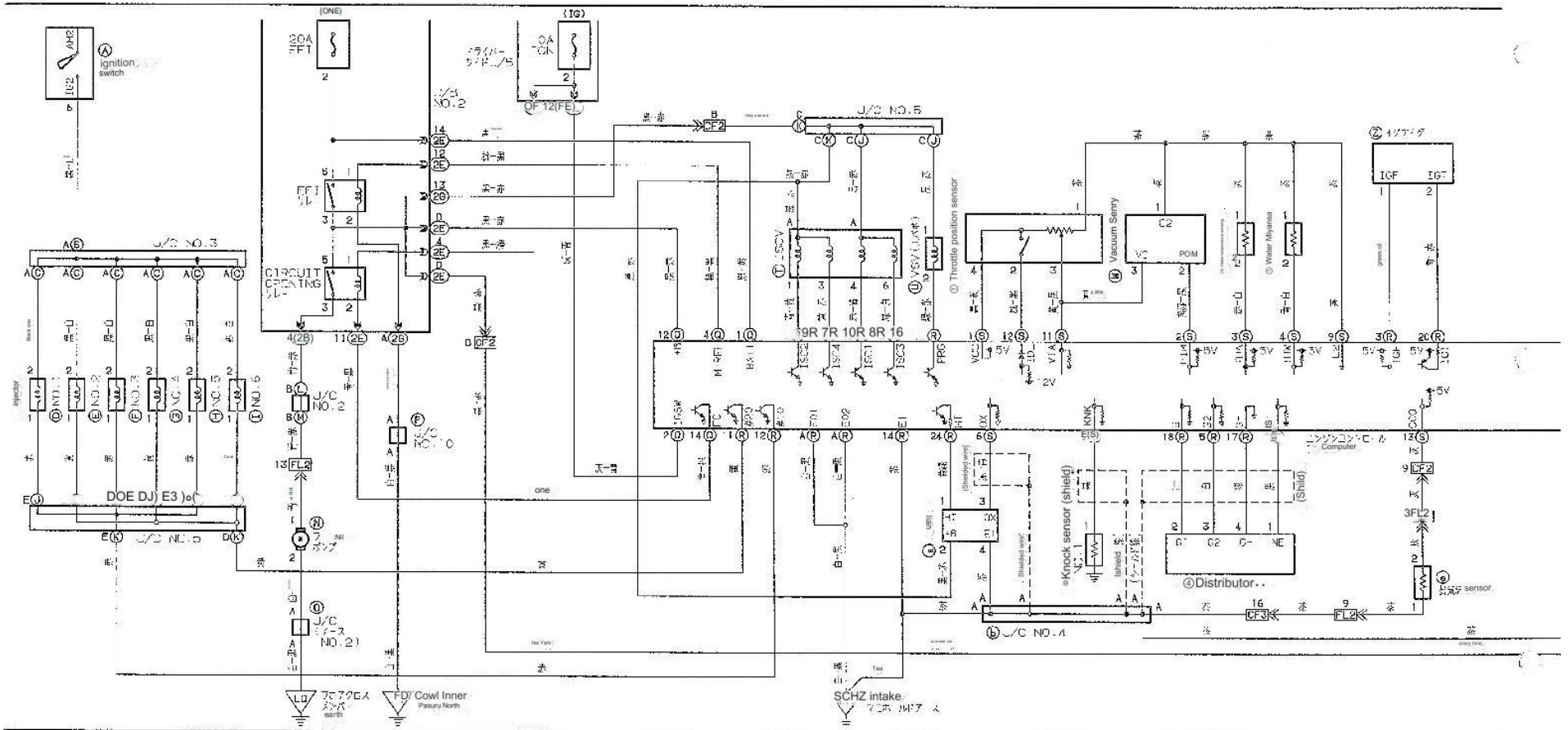

Product number 67476

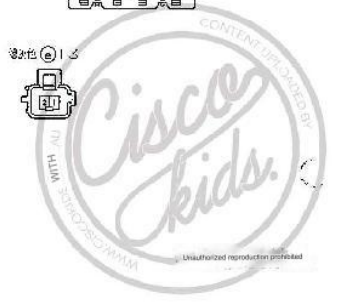

Unauthorized reproduction prohibited

Engine control (1G-FE)

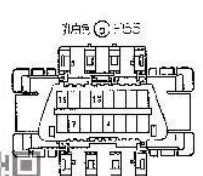
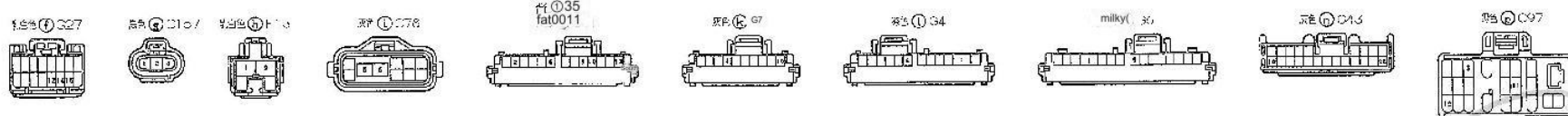
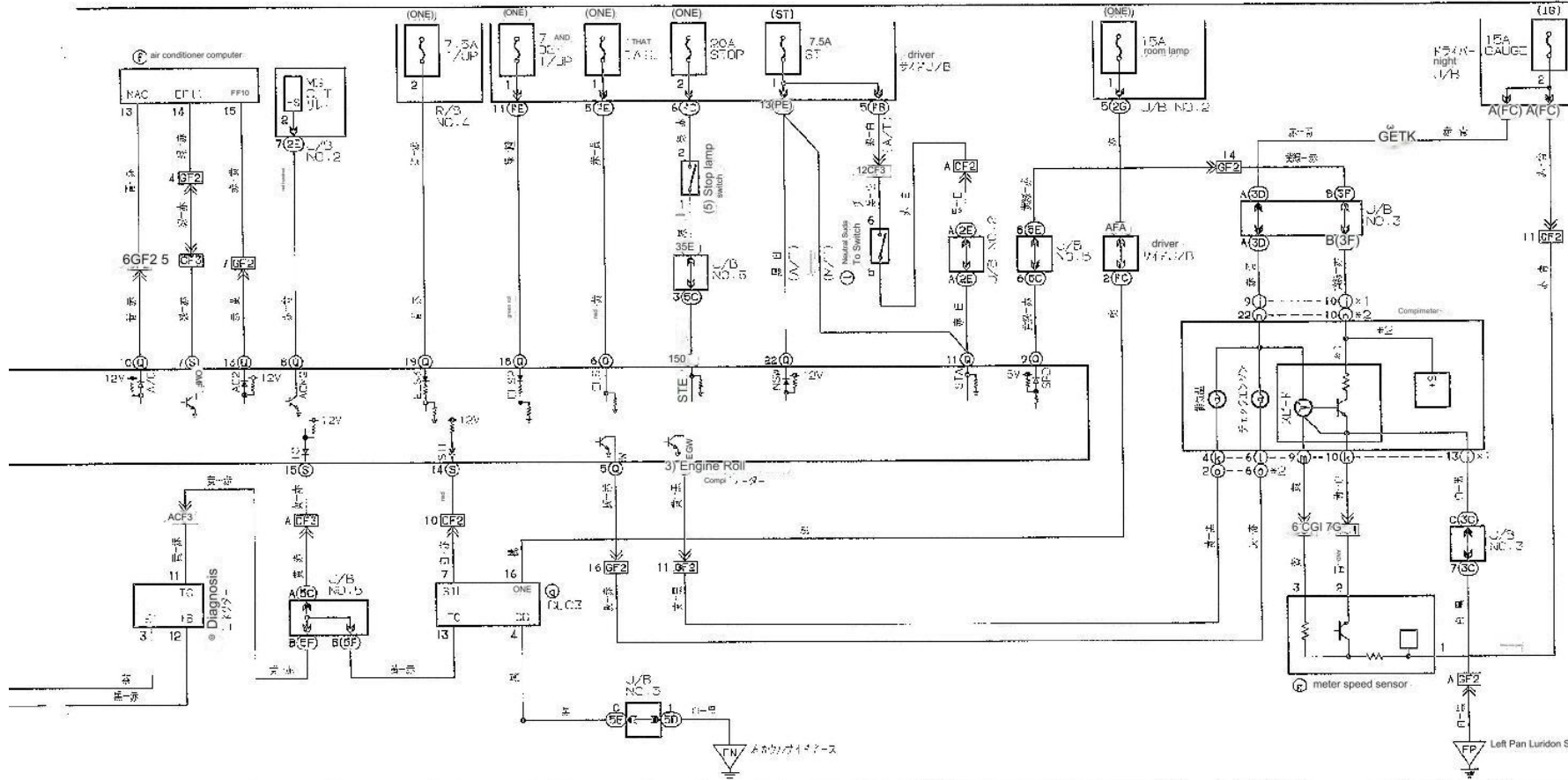

Engine control (1JZ-GE)

#1: 2D TRC included #3: Anonig meter
 #2: without DOTFC #4: Digital meter
 #5: 2WC +7: Grade *5: 2WC #3: 2WD WD with TRC

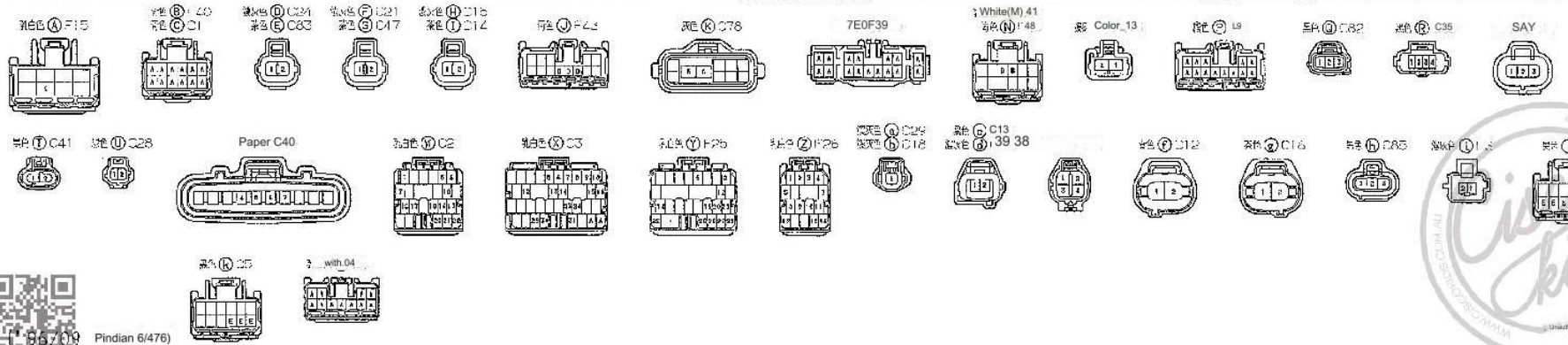
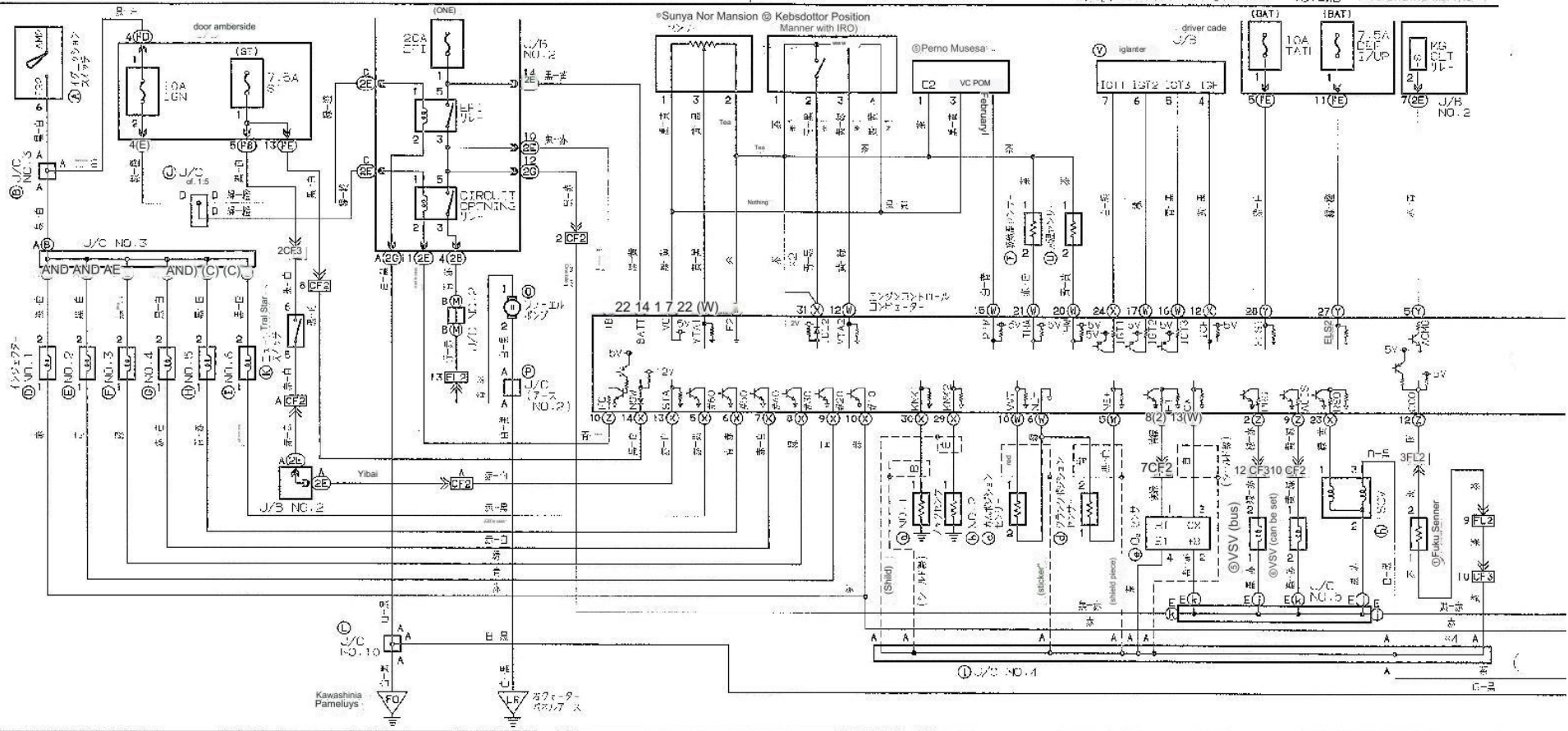

Pindian 6(476)

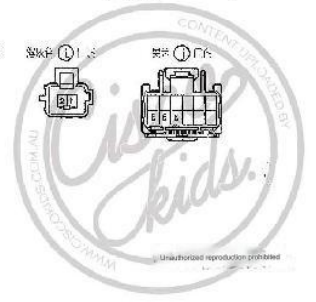

Engine control (1JZ-GE)

Charging

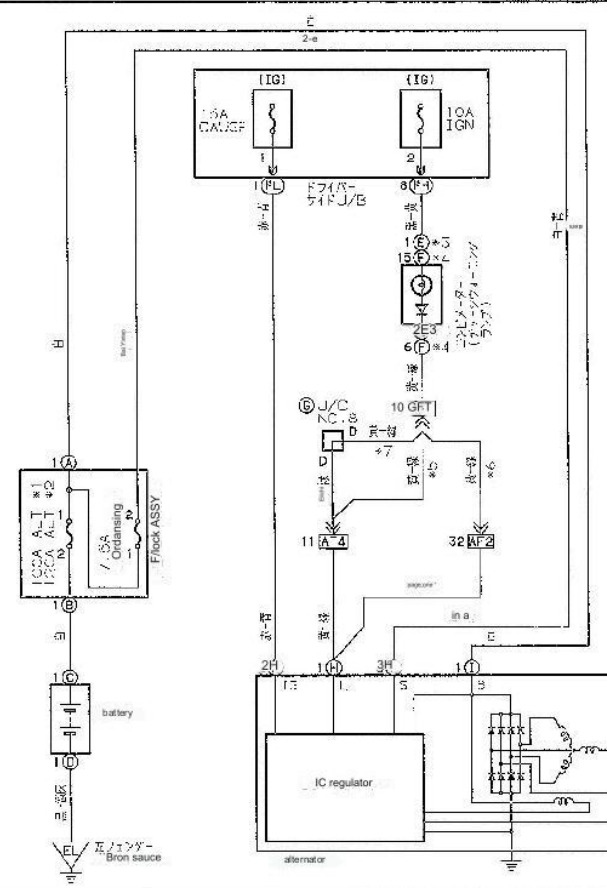
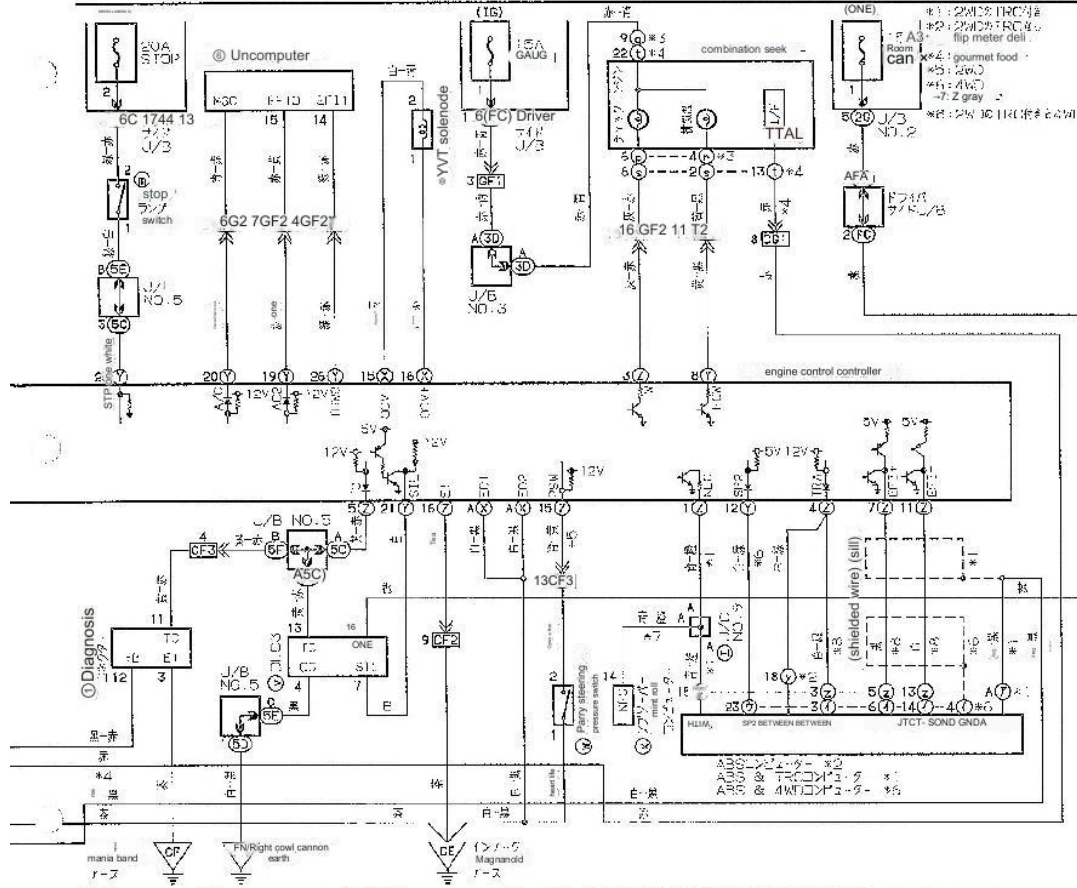

- *1: 1JZ-GE (1JZ-GE)
- *2: 1JZ-GE (1JZ-GE)
- *3: 1JZ-GE (1JZ-GE)
- *4: 1JZ-GE (1JZ-GE)
- *5: 1JZ-GE (1JZ-GE)
- *6: 1JZ-GE (1JZ-GE)
- *7: 1JZ-GE (1JZ-GE)
- *8: 1JZ-GE (1JZ-GE)
- *9: 1JZ-GE (1JZ-GE)
- *10: 1JZ-GE (1JZ-GE)
- *11: 1JZ-GE (1JZ-GE)
- *12: 1JZ-GE (1JZ-GE)
- *13: 1JZ-GE (1JZ-GE)
- *14: 1JZ-GE (1JZ-GE)
- *15: 1JZ-GE (1JZ-GE)
- *16: 1JZ-GE (1JZ-GE)
- *17: 1JZ-GE (1JZ-GE)
- *18: 1JZ-GE (1JZ-GE)
- *19: 1JZ-GE (1JZ-GE)
- *20: 1JZ-GE (1JZ-GE)
- *21: 1JZ-GE (1JZ-GE)
- *22: 1JZ-GE (1JZ-GE)
- *23: 1JZ-GE (1JZ-GE)
- *24: 1JZ-GE (1JZ-GE)
- *25: 1JZ-GE (1JZ-GE)
- *26: 1JZ-GE (1JZ-GE)
- *27: 1JZ-GE (1JZ-GE)
- *28: 1JZ-GE (1JZ-GE)
- *29: 1JZ-GE (1JZ-GE)
- *30: 1JZ-GE (1JZ-GE)
- *31: 1JZ-GE (1JZ-GE)
- *32: 1JZ-GE (1JZ-GE)
- *33: 1JZ-GE (1JZ-GE)
- *34: 1JZ-GE (1JZ-GE)
- *35: 1JZ-GE (1JZ-GE)
- *36: 1JZ-GE (1JZ-GE)
- *37: 1JZ-GE (1JZ-GE)
- *38: 1JZ-GE (1JZ-GE)
- *39: 1JZ-GE (1JZ-GE)
- *40: 1JZ-GE (1JZ-GE)
- *41: 1JZ-GE (1JZ-GE)
- *42: 1JZ-GE (1JZ-GE)
- *43: 1JZ-GE (1JZ-GE)
- *44: 1JZ-GE (1JZ-GE)
- *45: 1JZ-GE (1JZ-GE)
- *46: 1JZ-GE (1JZ-GE)
- *47: 1JZ-GE (1JZ-GE)
- *48: 1JZ-GE (1JZ-GE)
- *49: 1JZ-GE (1JZ-GE)
- *50: 1JZ-GE (1JZ-GE)

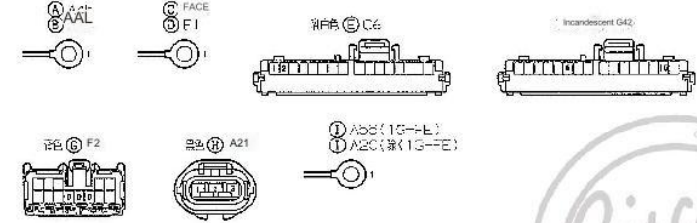
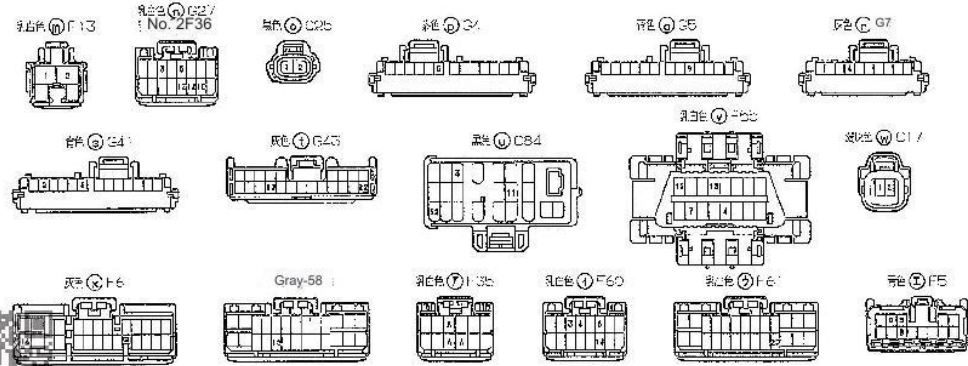

Engine control (1JZ-GTE)

*1: K/T
*2: A/T

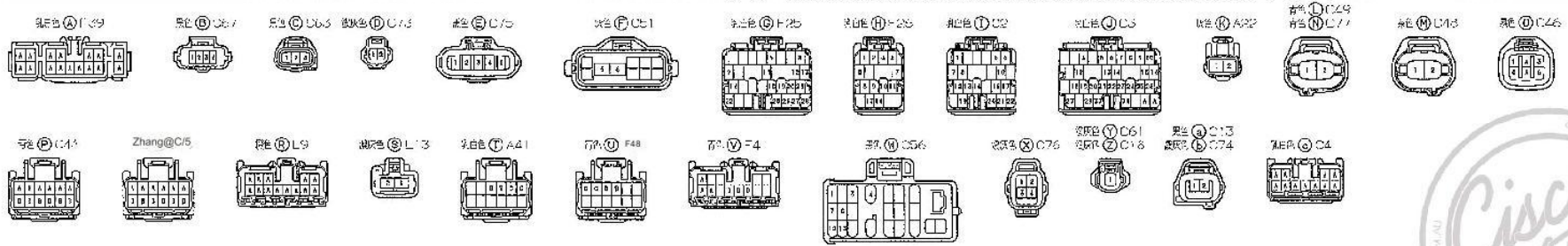
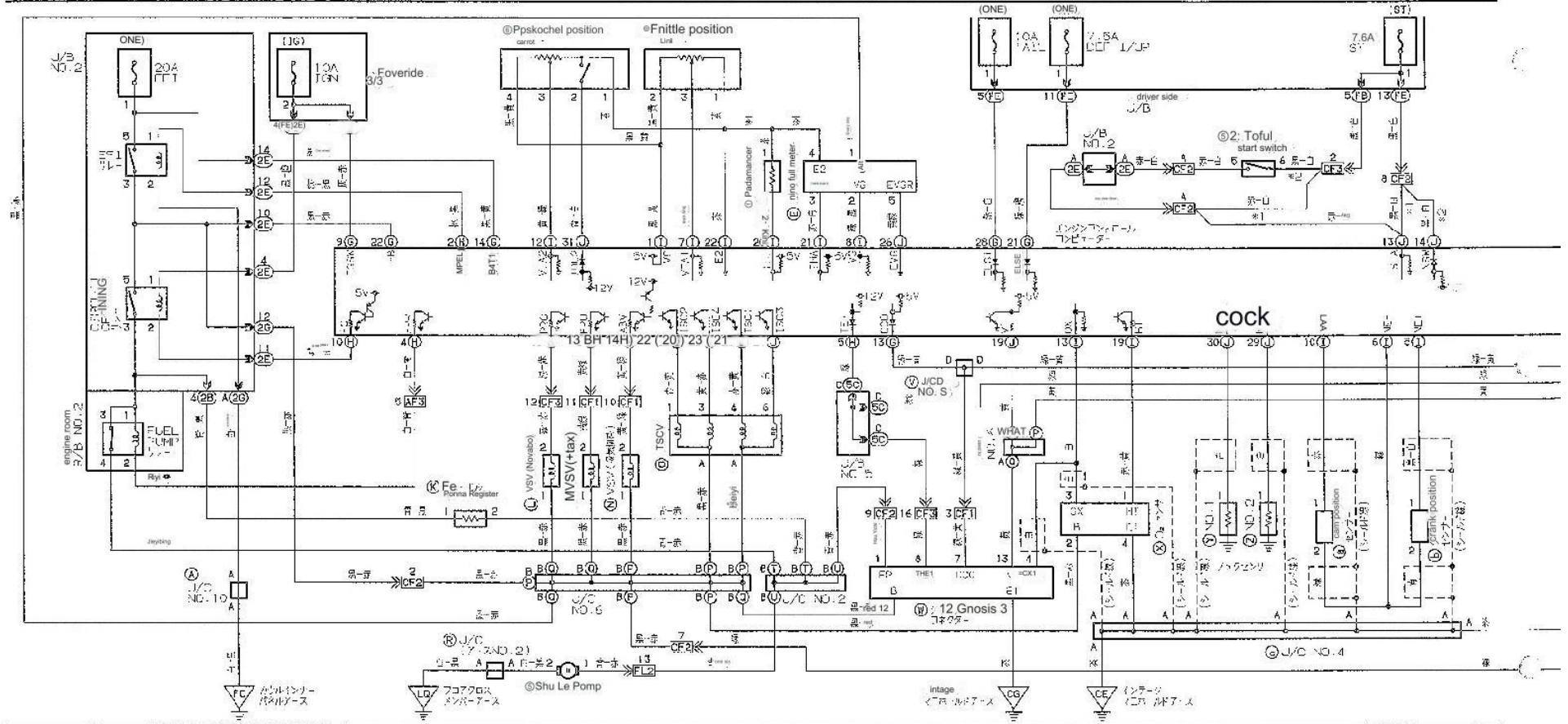

Product number 67476



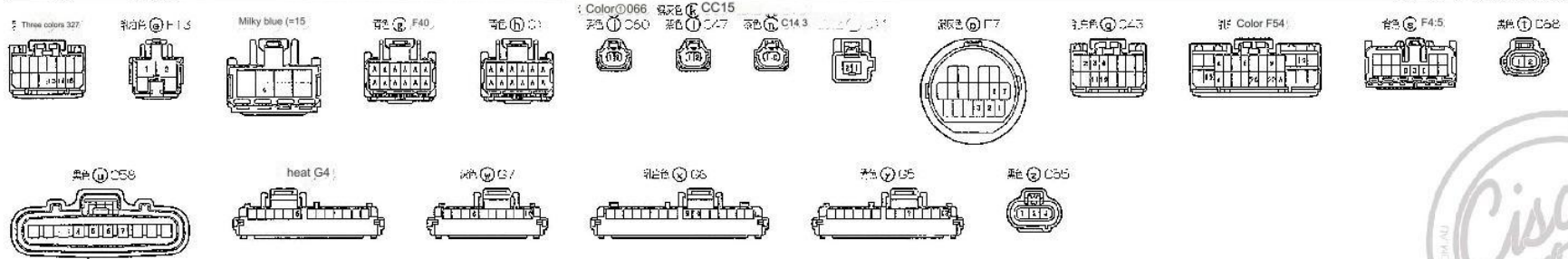
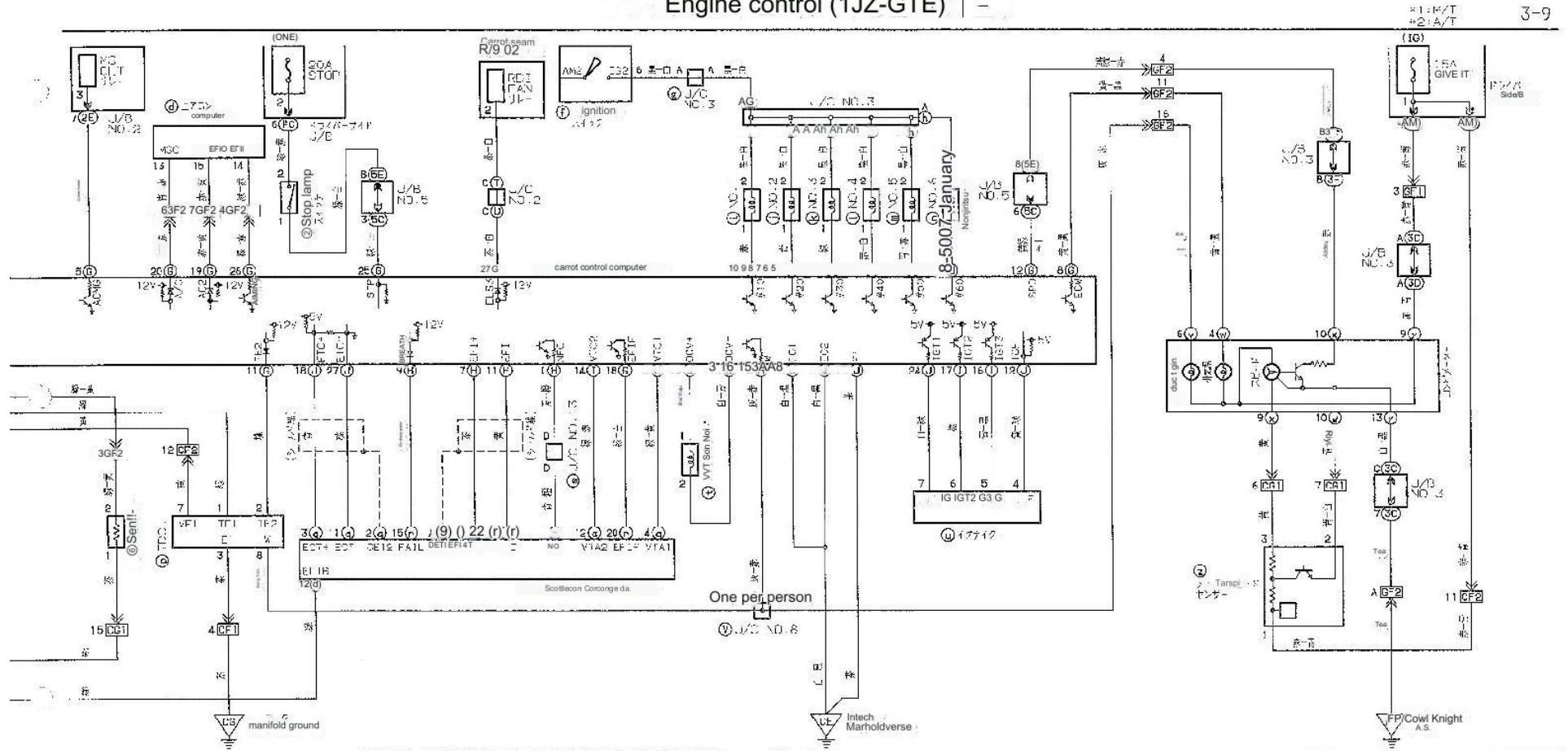

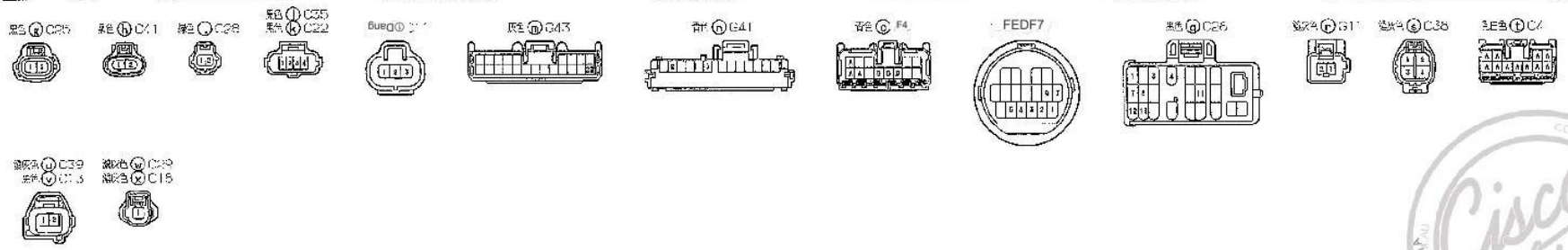
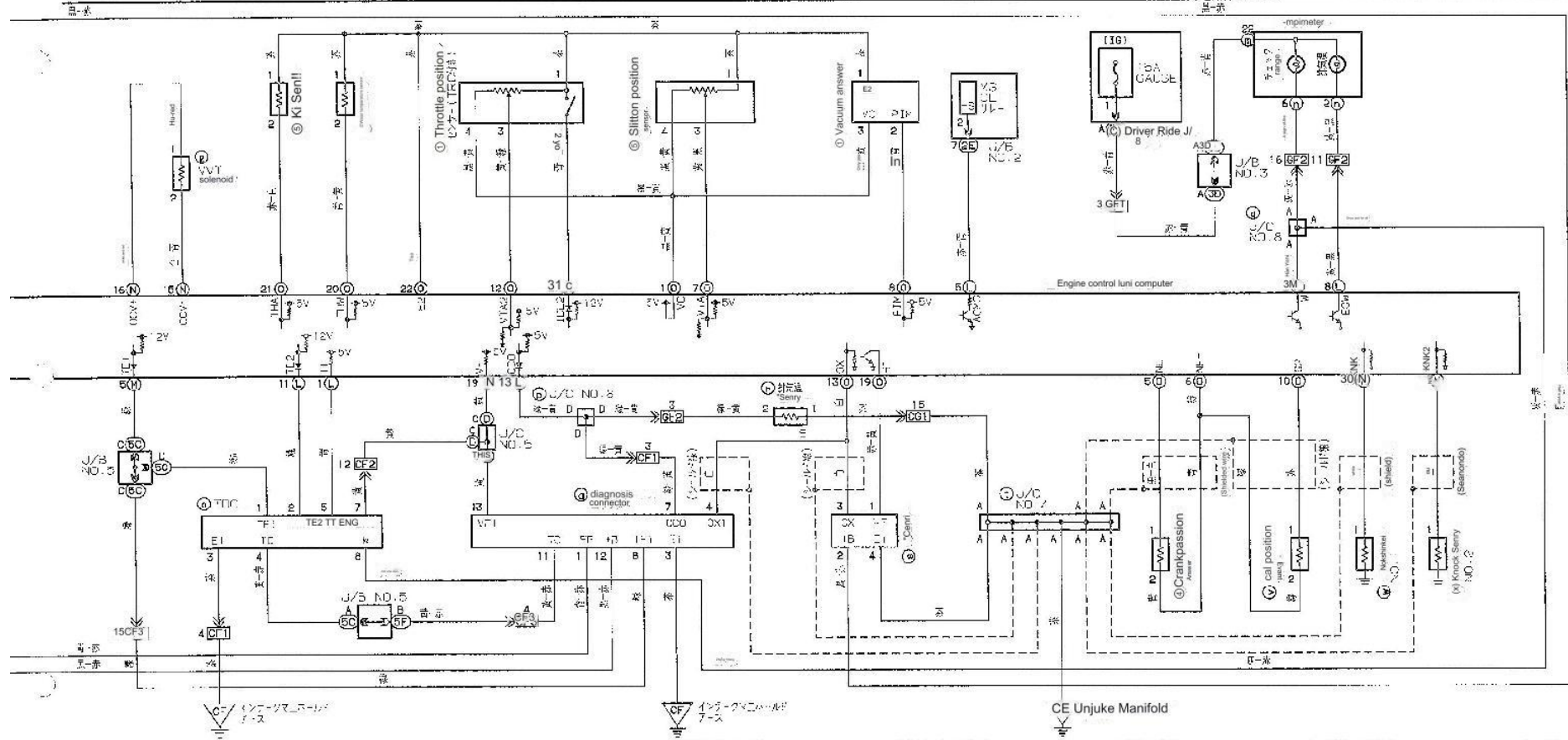

(196/09 品番67476)

Engine control (diesel)

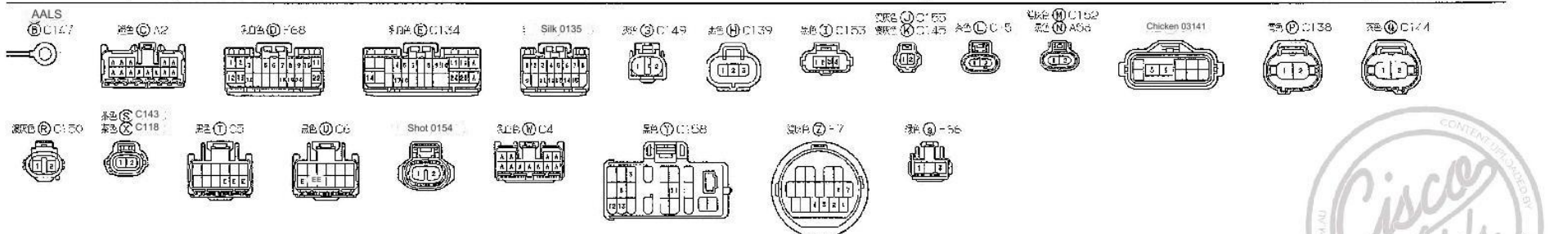
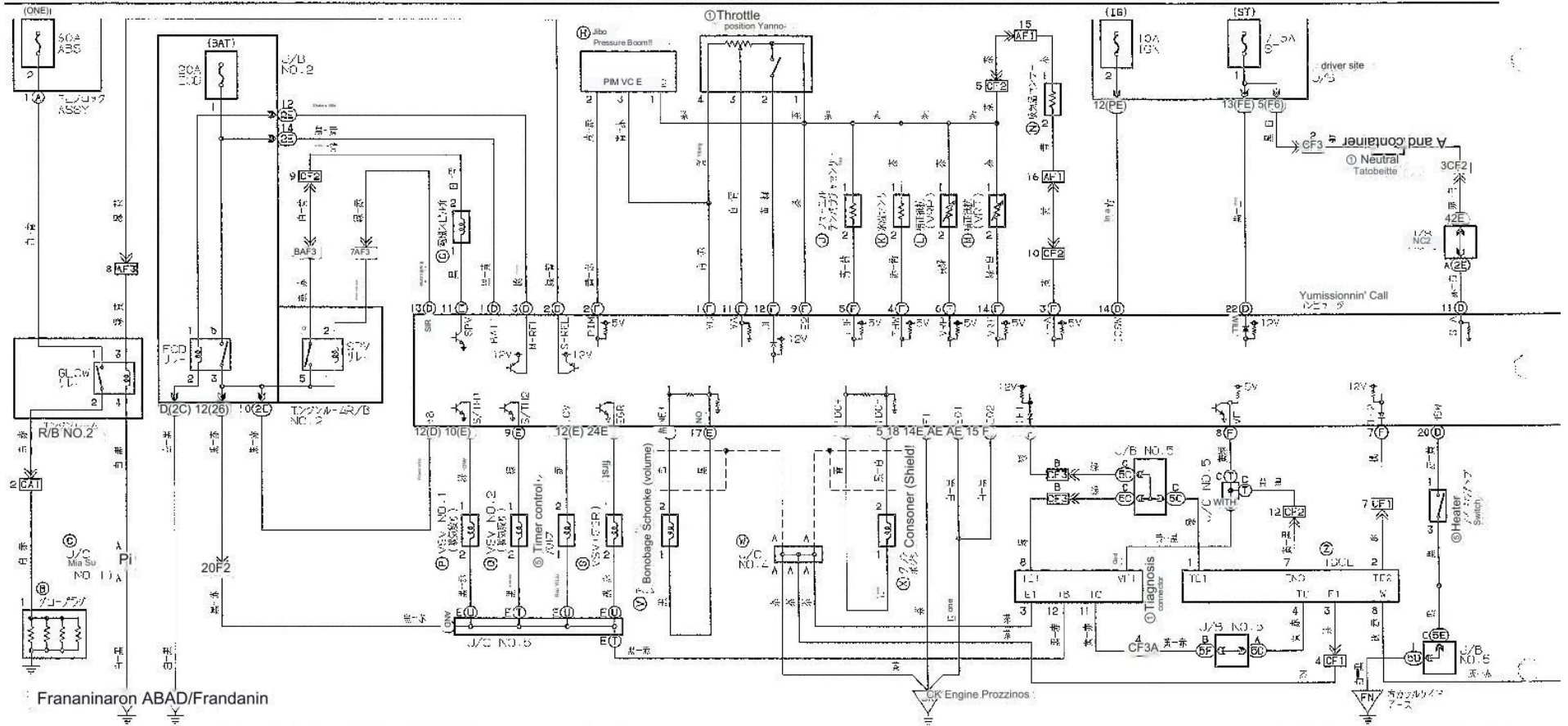

Engine control (diesel)

cooling fan

fuel pider (diesel) 3-13

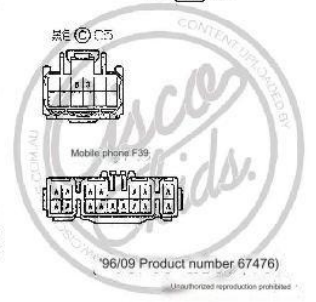
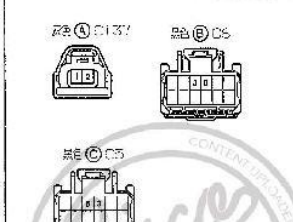
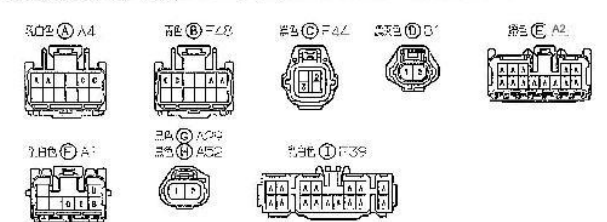
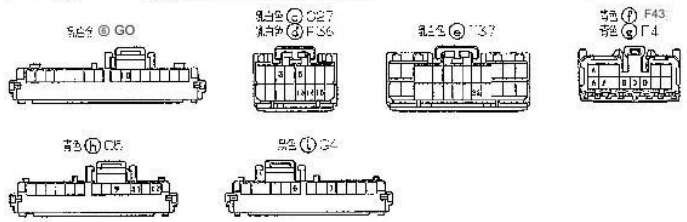
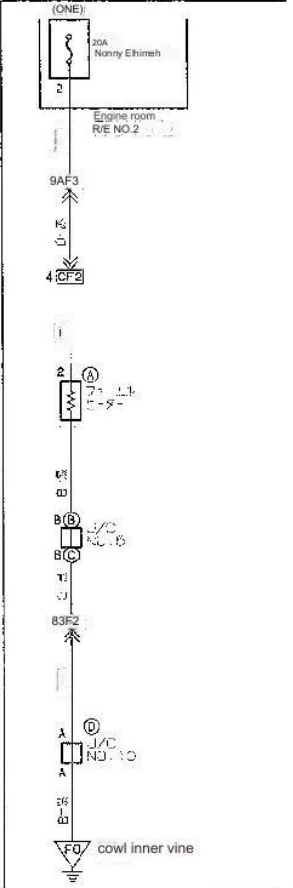
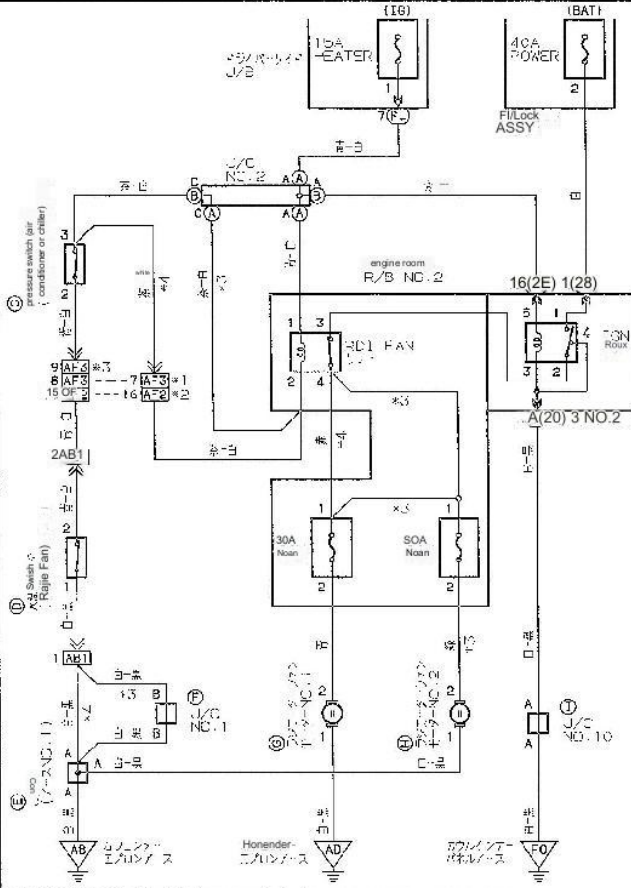
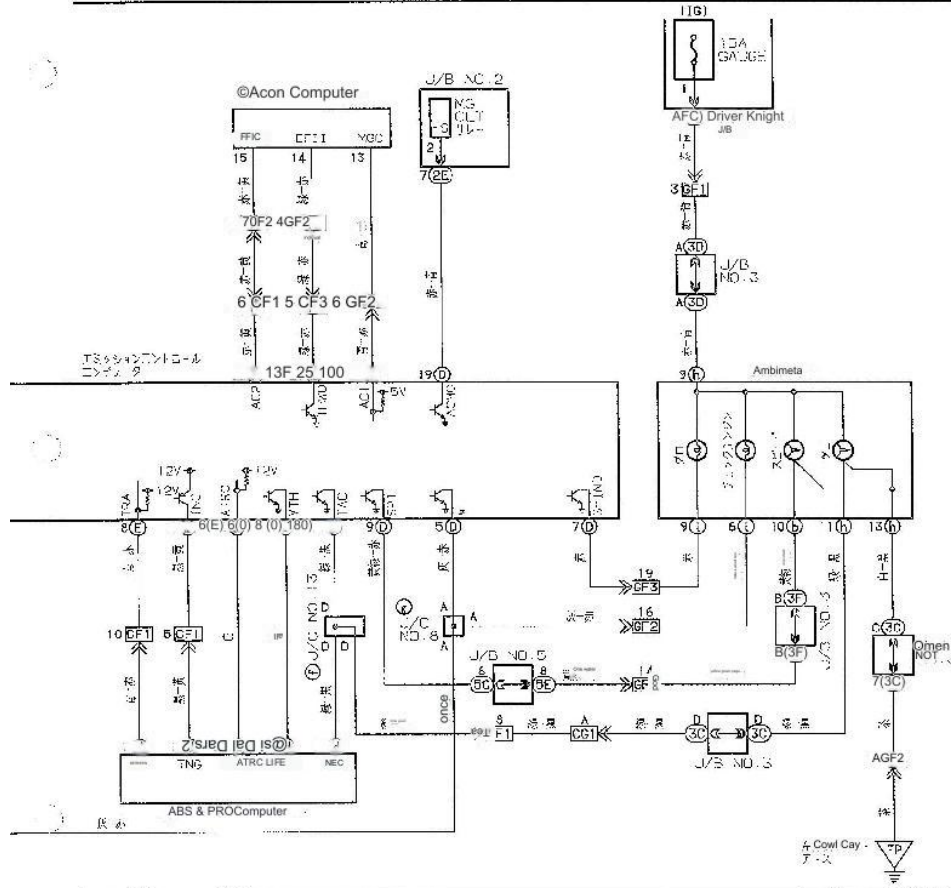

ECT (1JZ-GE)

* : D x3 Sgrade #52WTRC(L *A: Straight
 +22WD 赤: 2x2のTRC赤き +6: 6x1のTRC
 B: Anonymous/Ta... *A: Digital meter

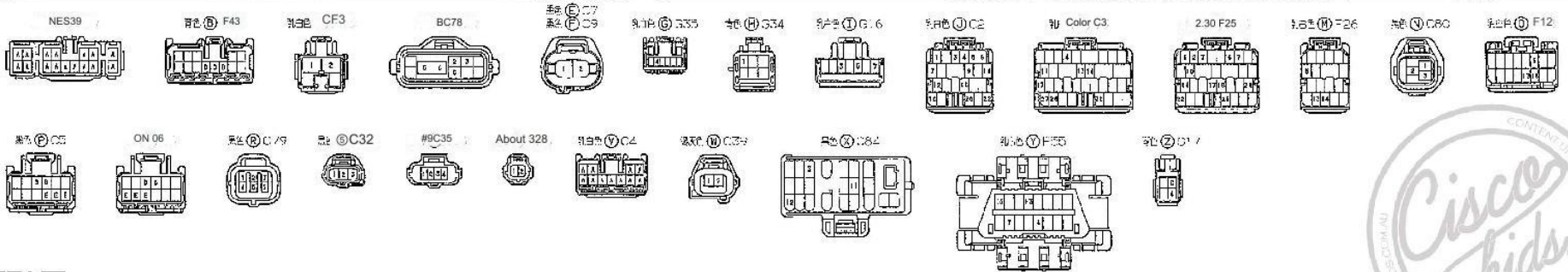
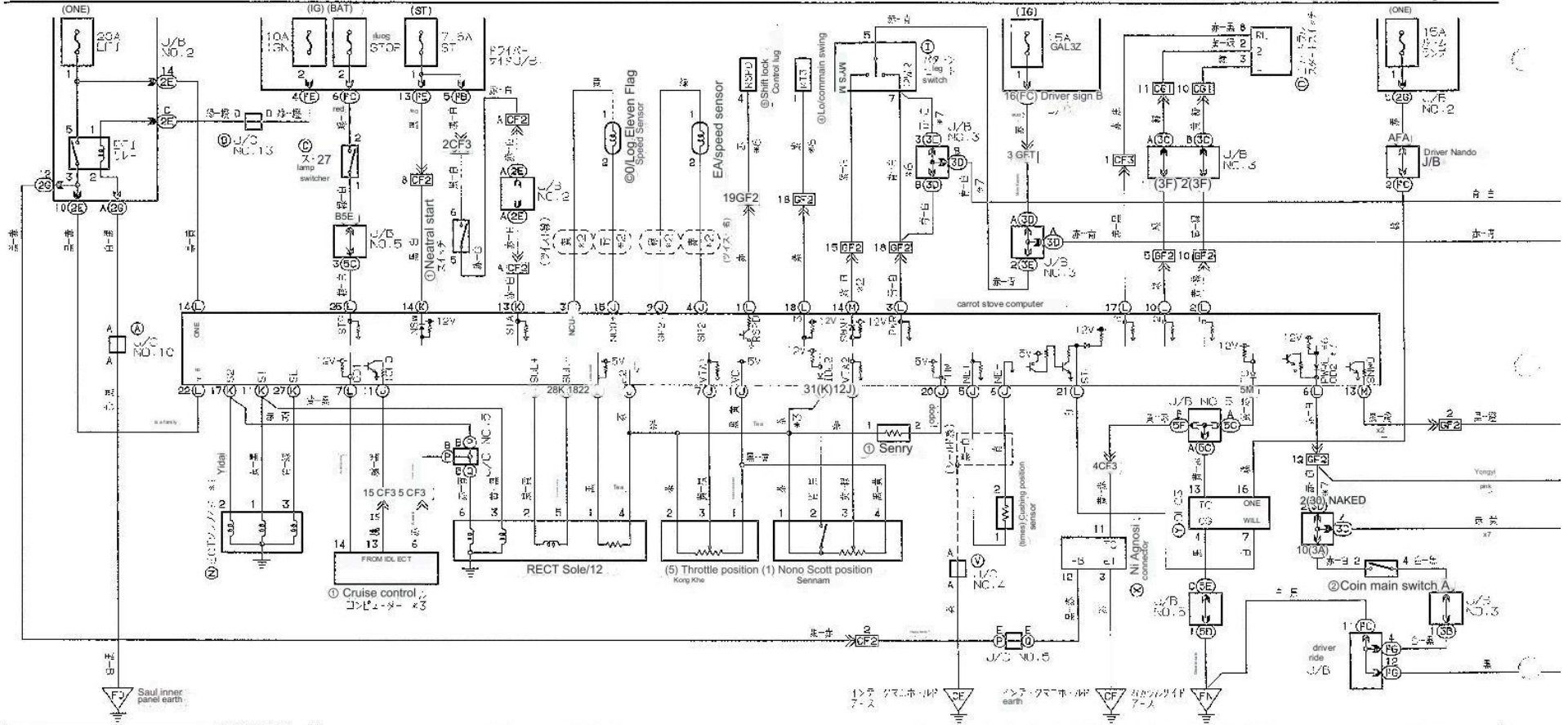

Product number 67478



ECT (1JZ-GE)

Skyhook Control Suspension (TEMS)

1/VSC 3; No TRC 5, 12, CE
 2/VSC 3; 1+1; HCU 有 付 R6: 1JZ-GE 3-15

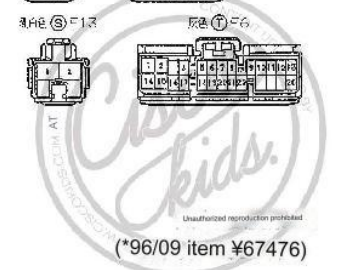
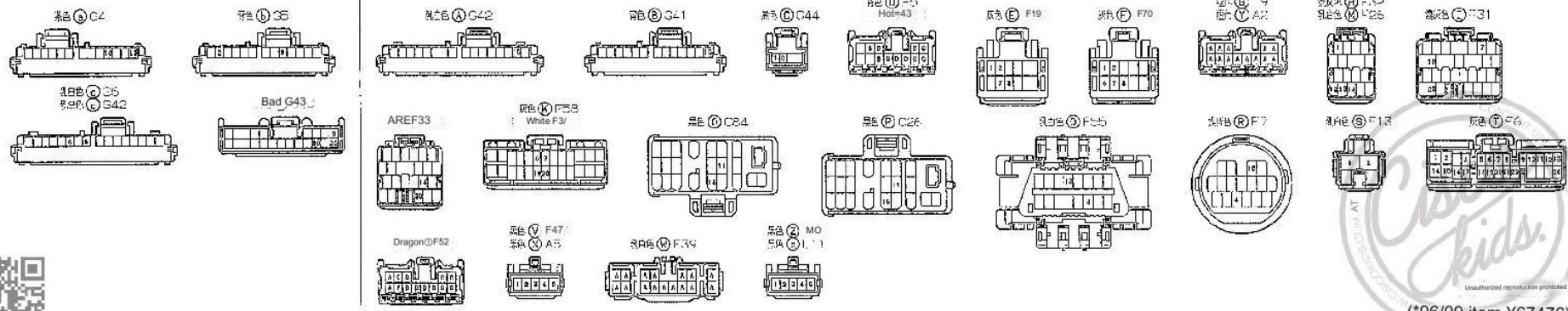
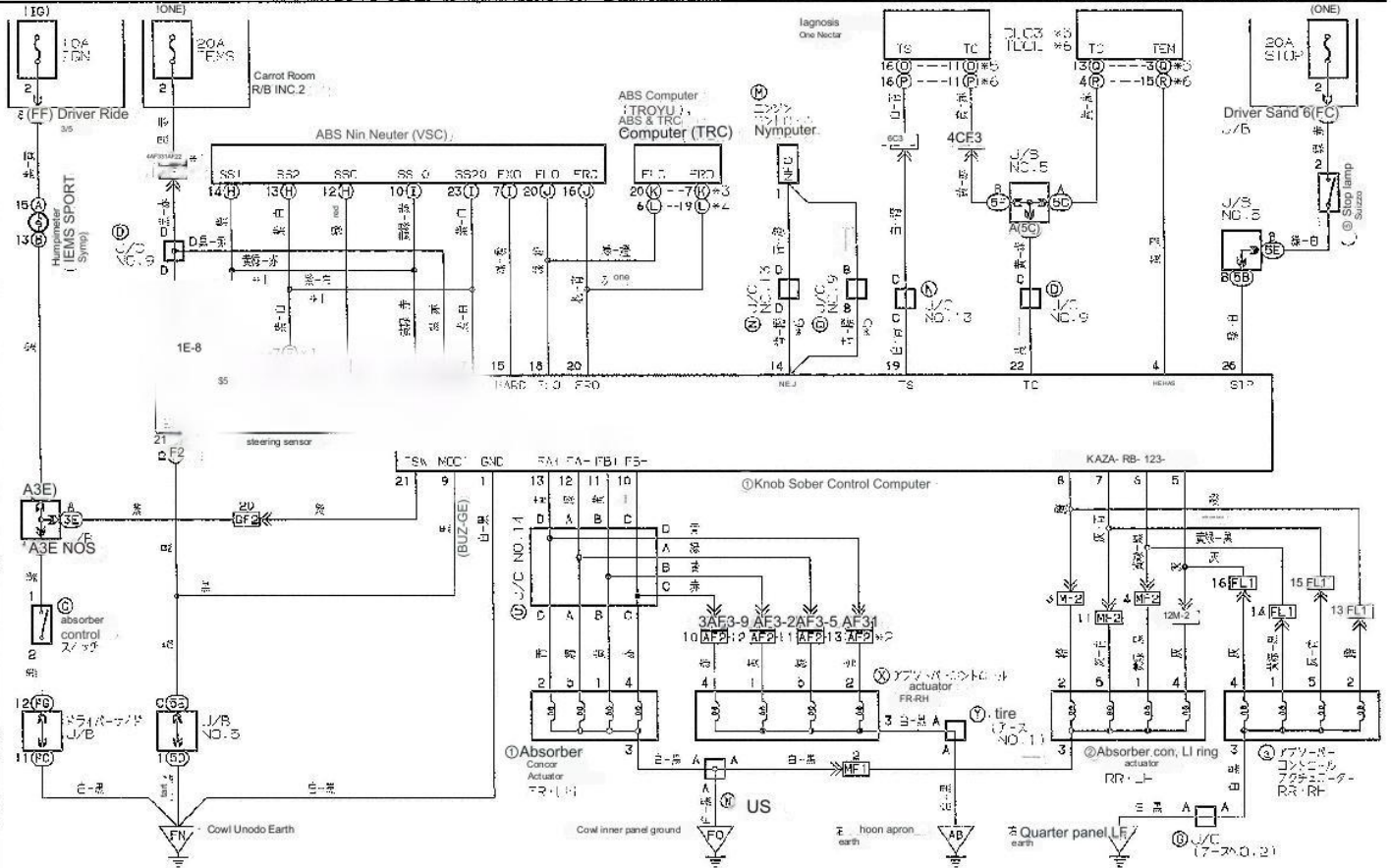
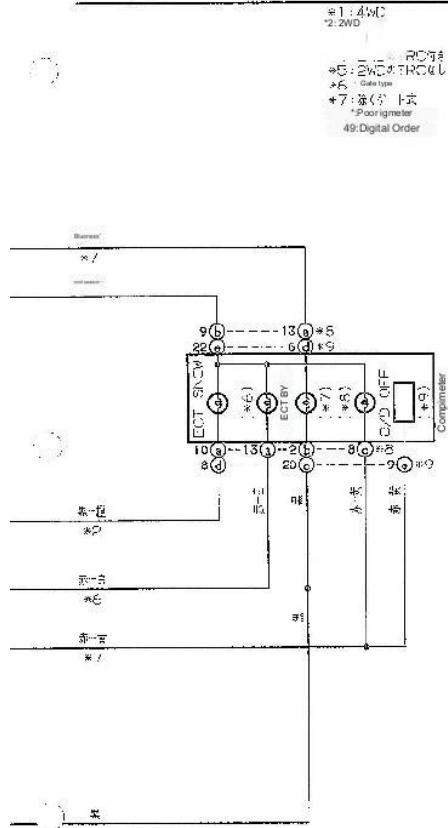

ECT (1JZ-GTE)

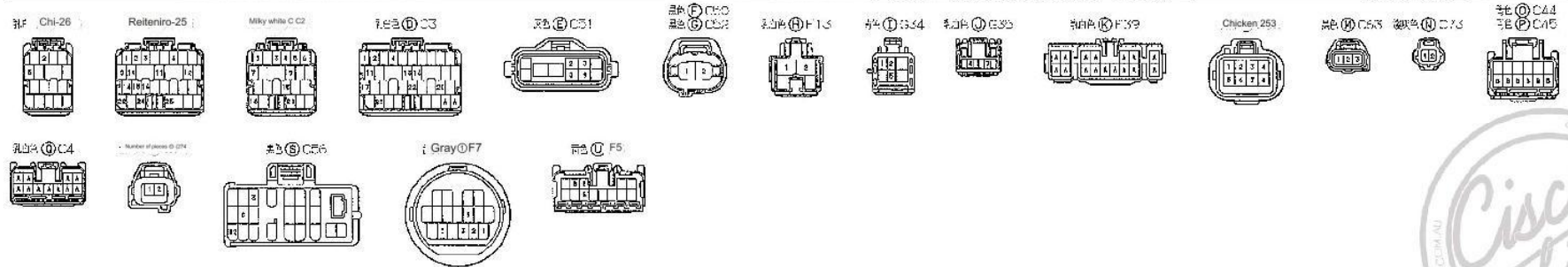
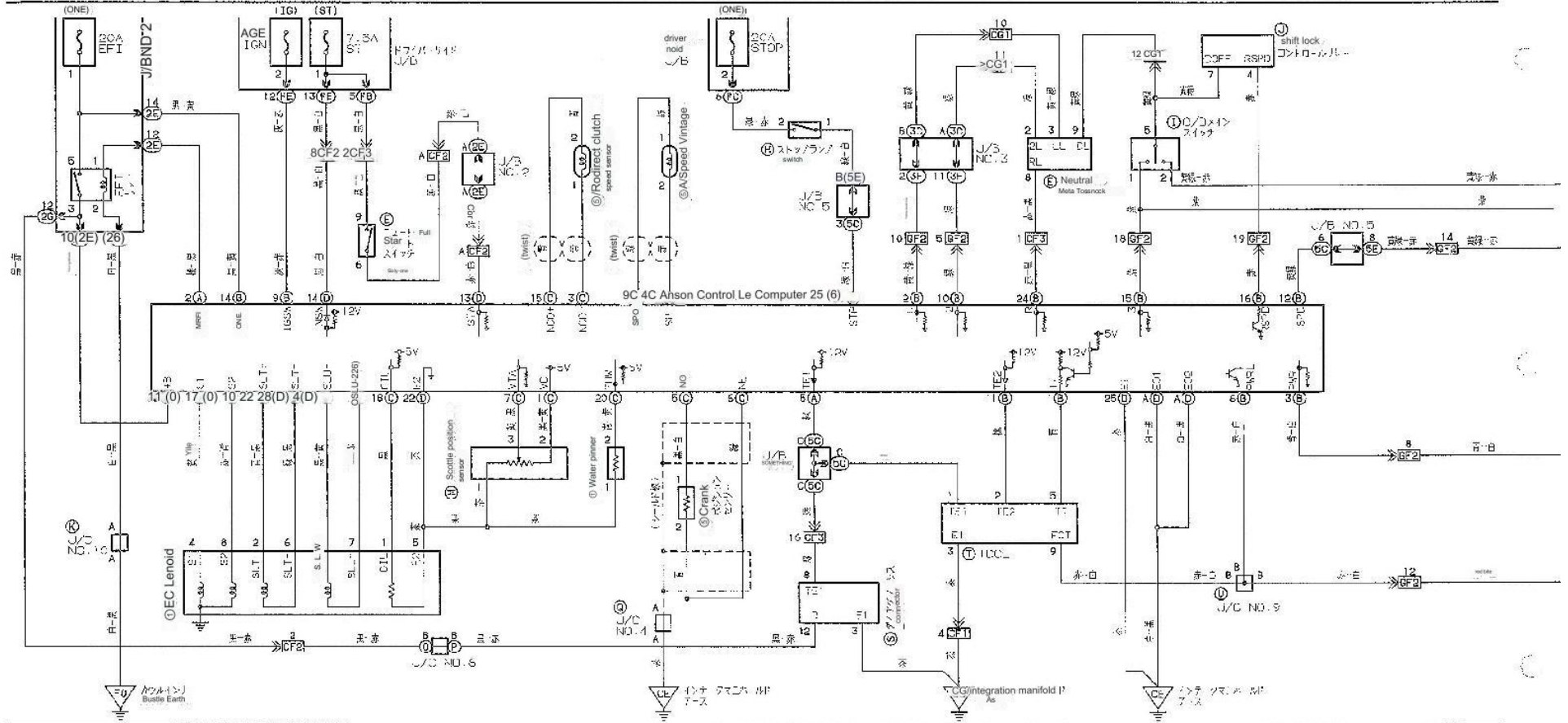

Product number 674761



ECT (2JZ-GE)

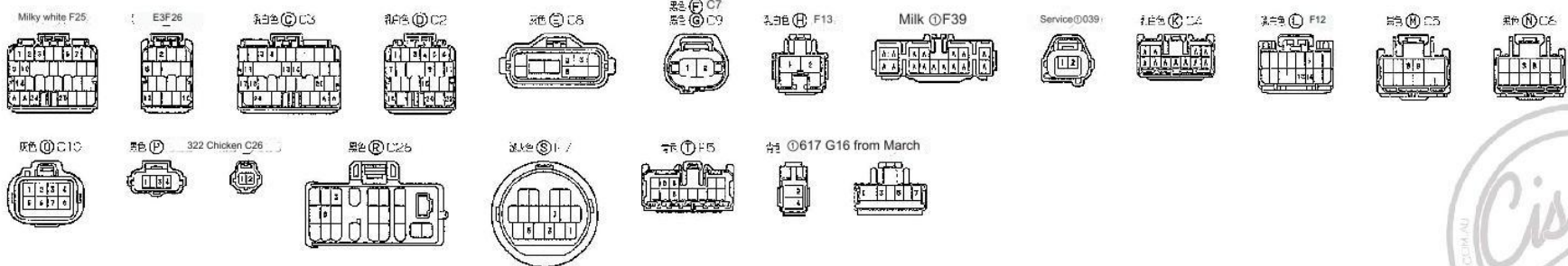
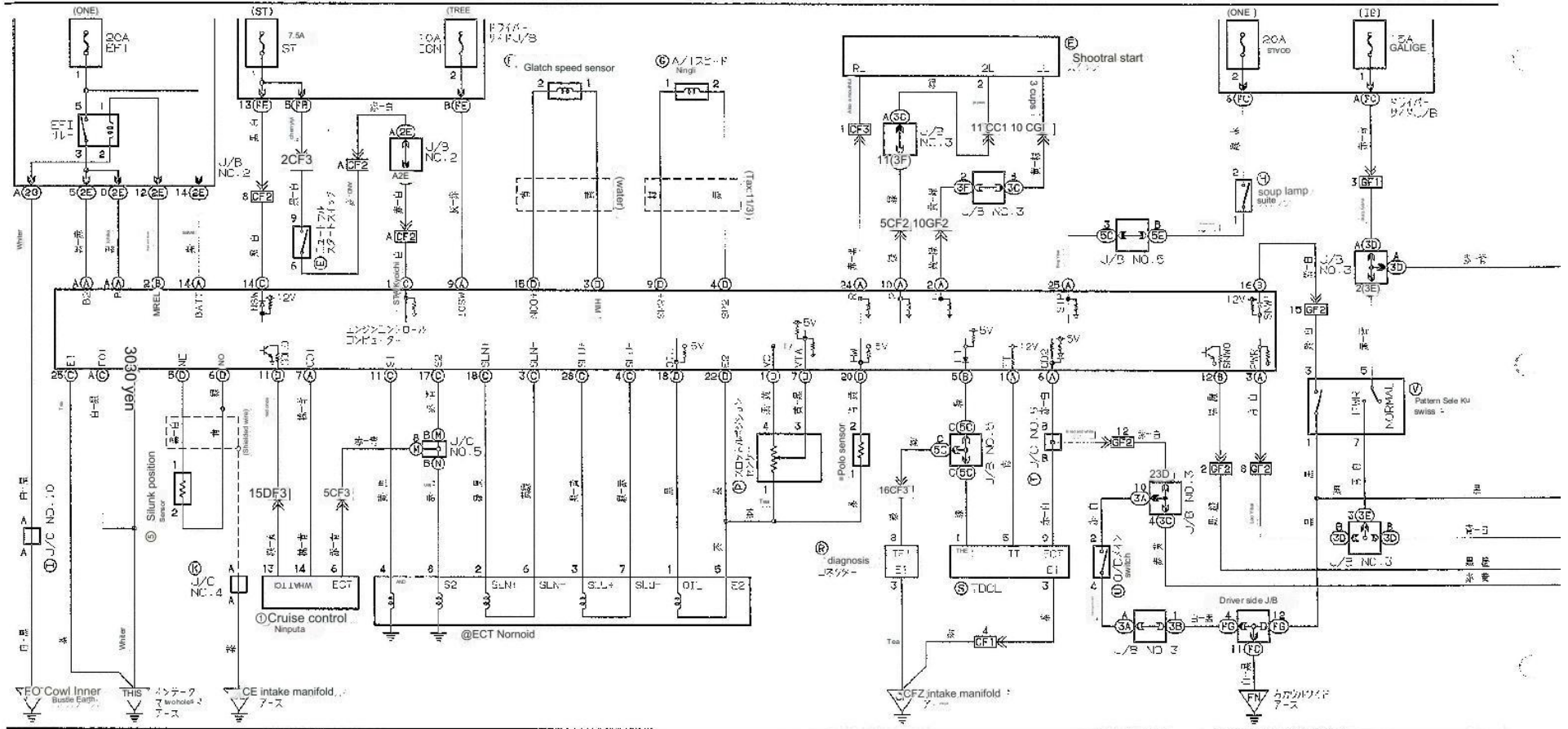

Product number 5481



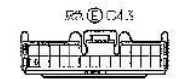
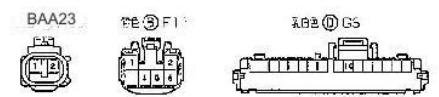
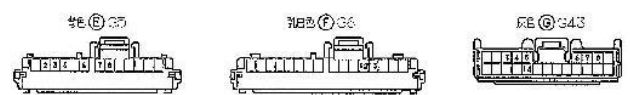
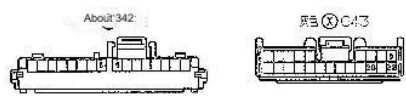
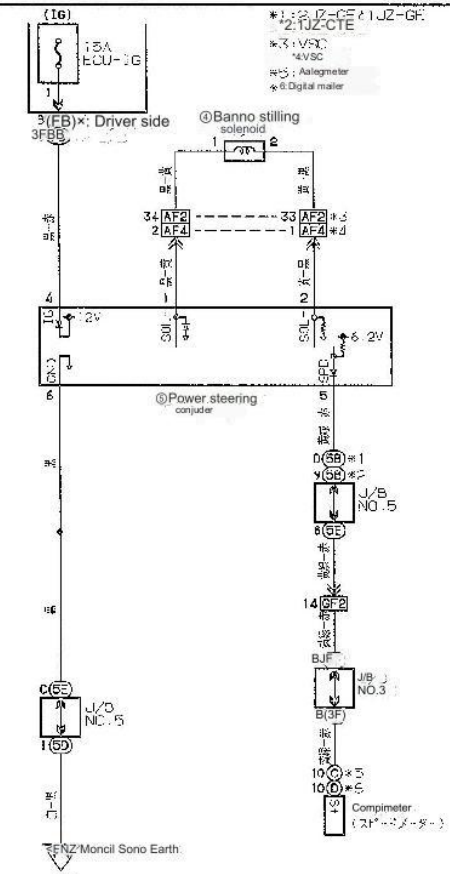
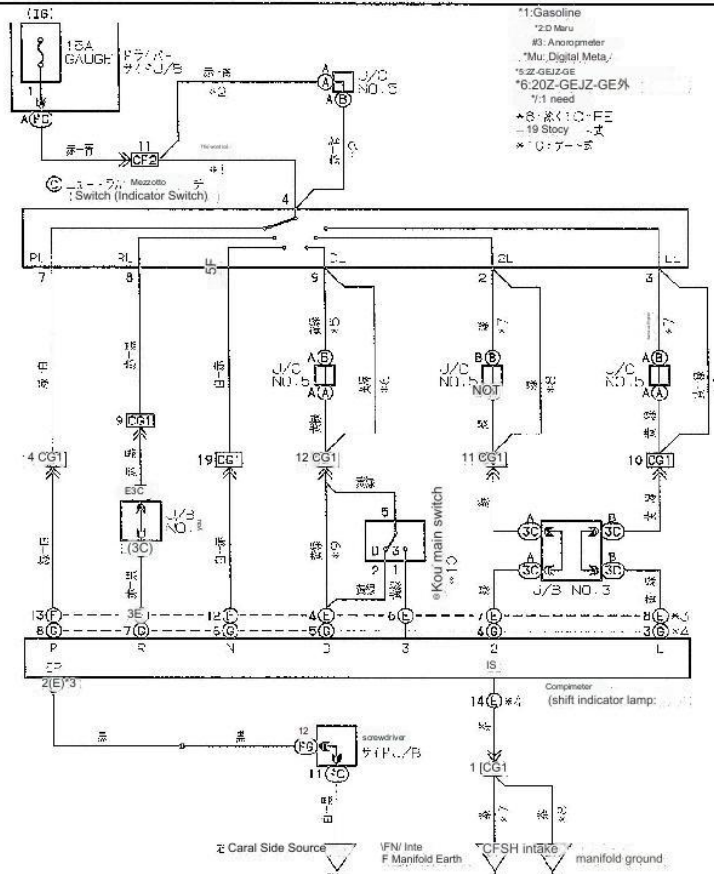
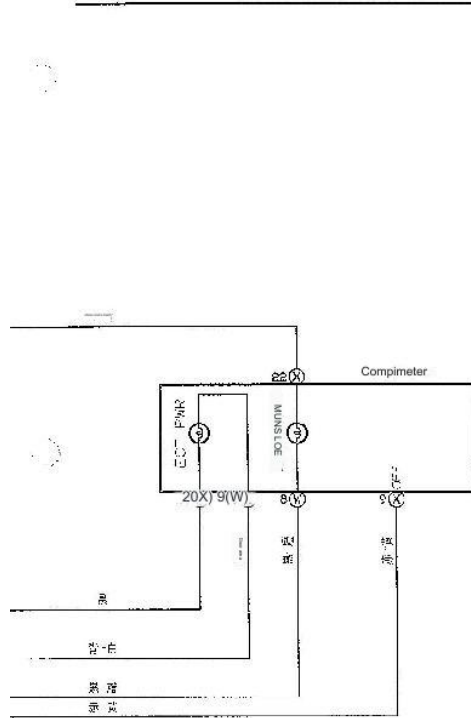

ECT (1G-FE)

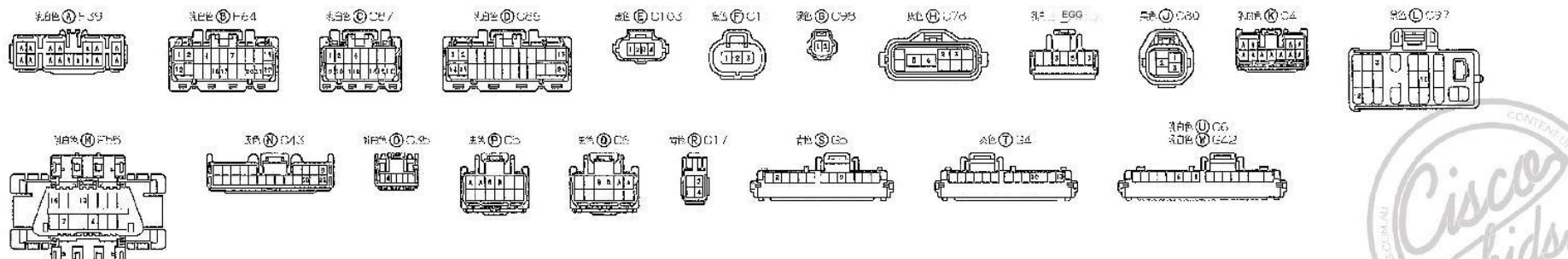
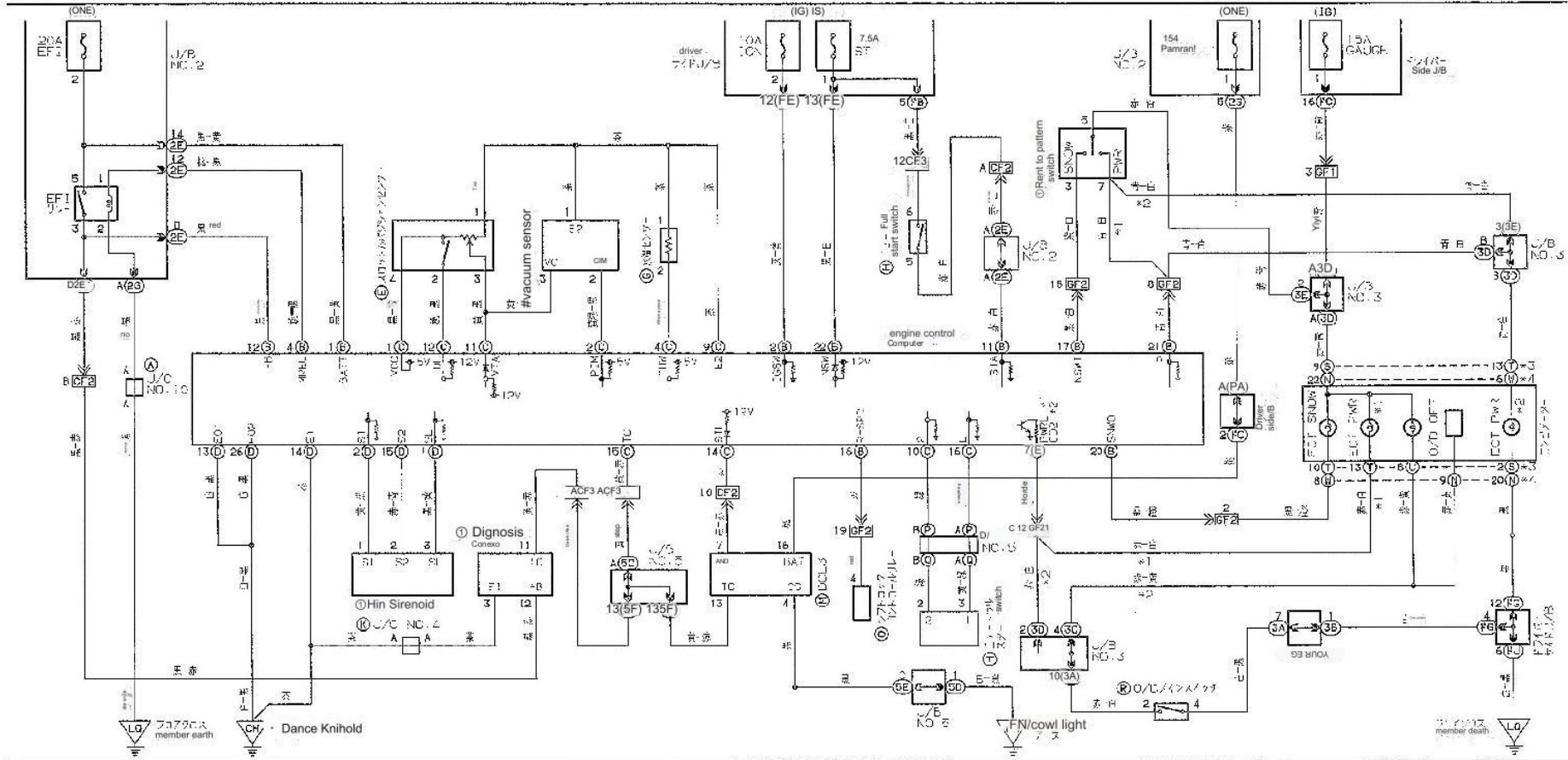

67 C9 67476)



near bag

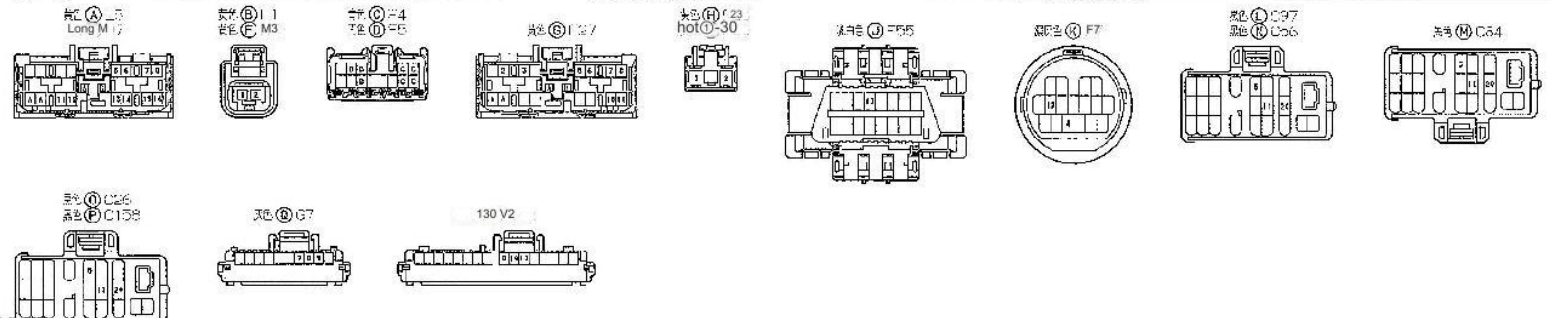
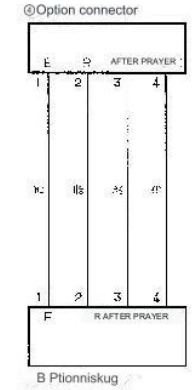
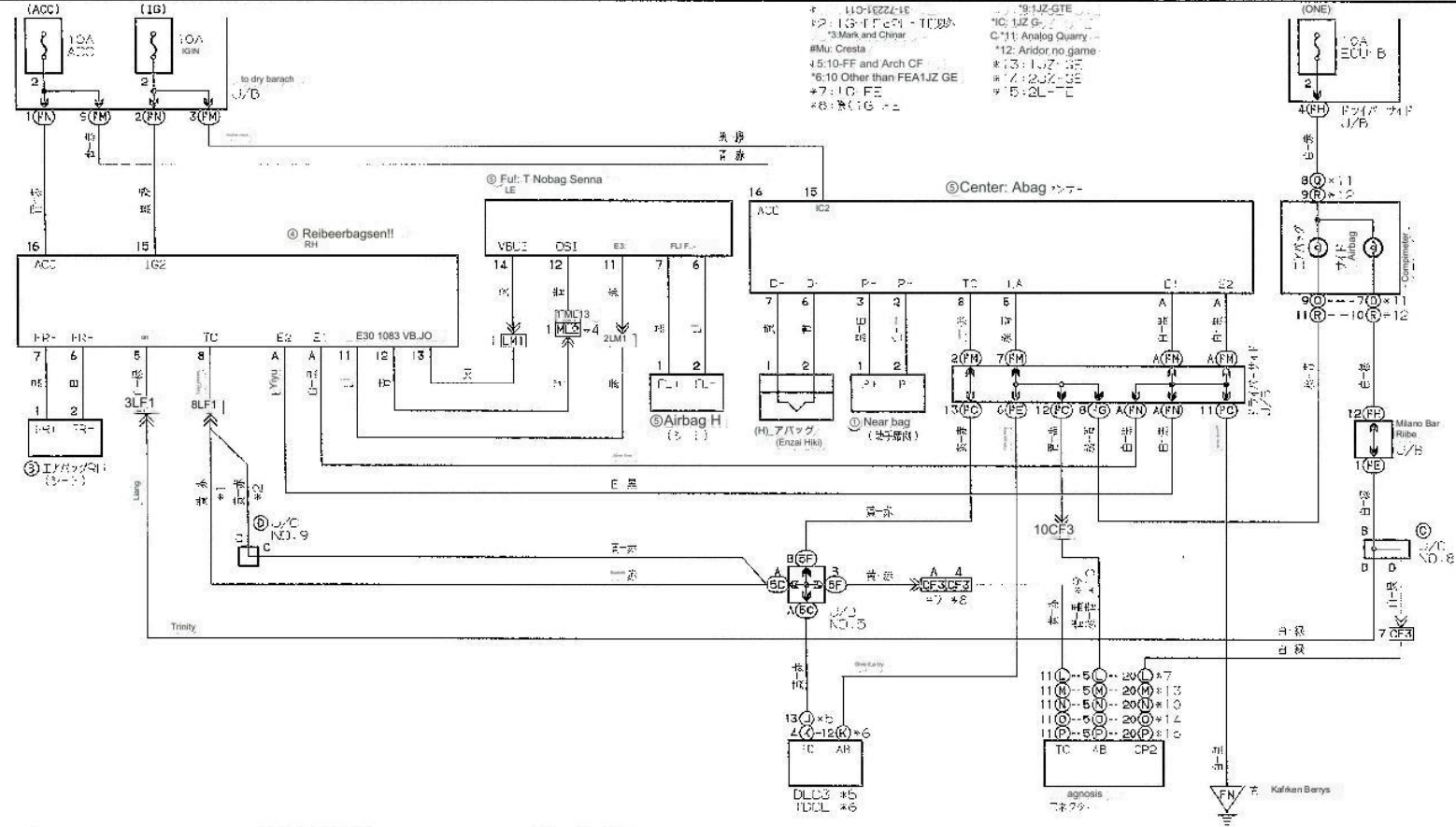

ABS (without TRC)

#1: Excluding grade
 #2: Pre-drill
 #3: 1G-FE
 #4: 2G-FE
 #5: 2G-TE
 #6: 2G-TE
 #7: A: Aang meter
 #8: Atznoder
 #9: 1G-FE AT
 #10: 2G-FE
 #11: 1G-GE
 #12: 2G-GE

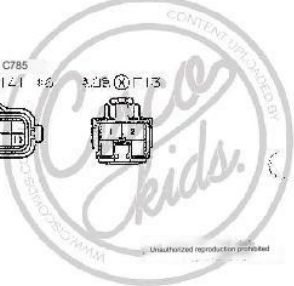
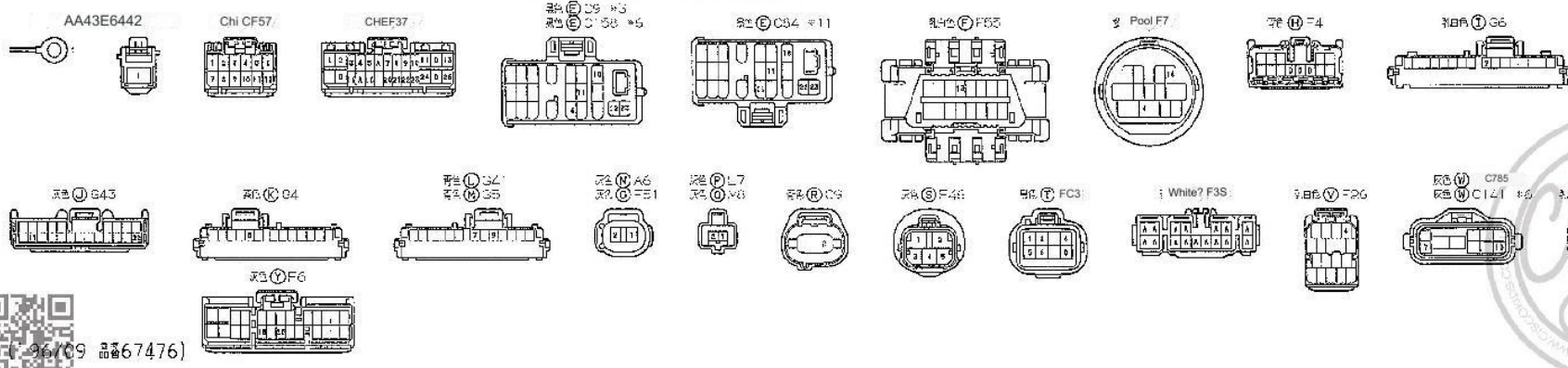
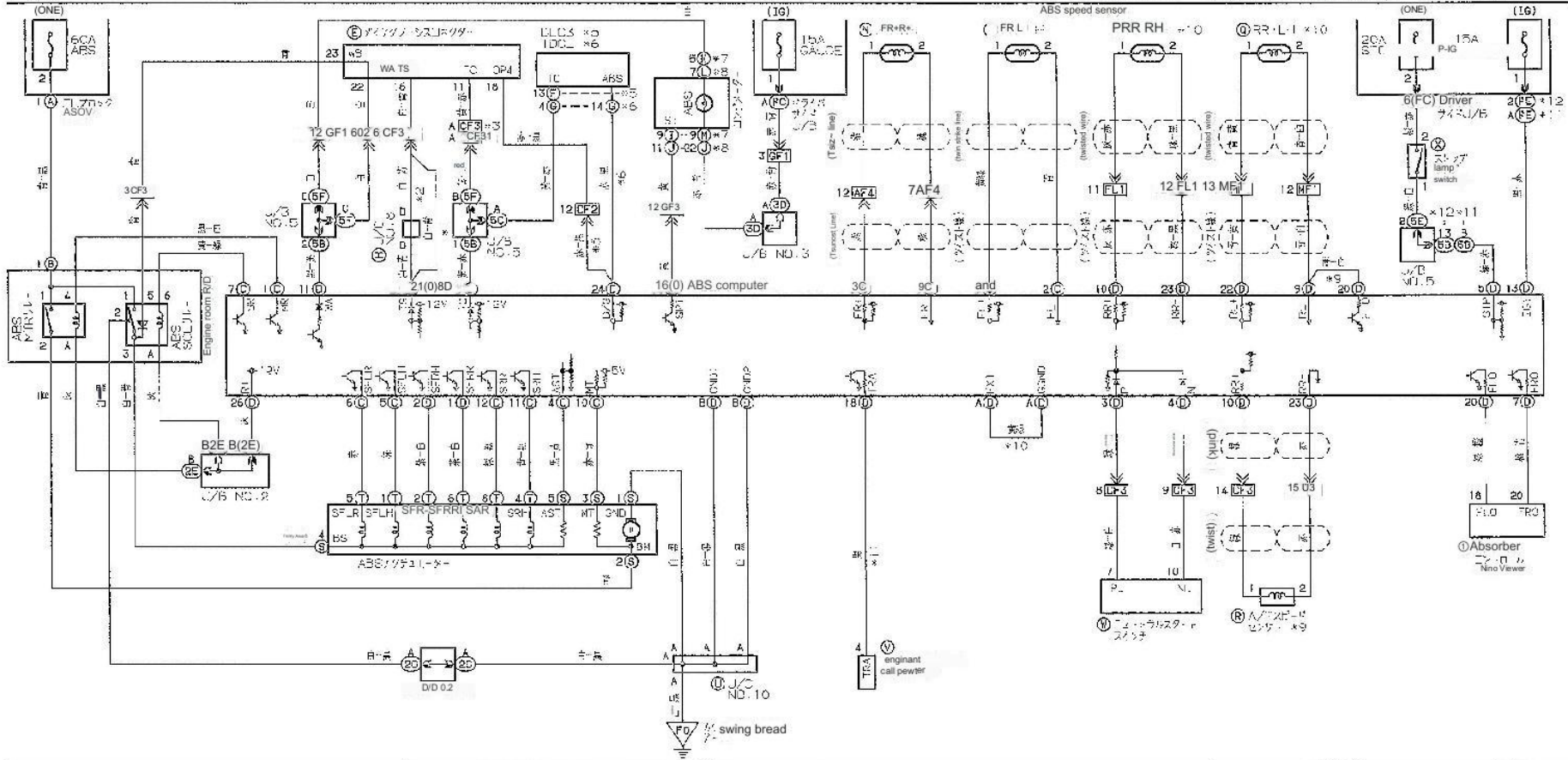

ABS & 4WD

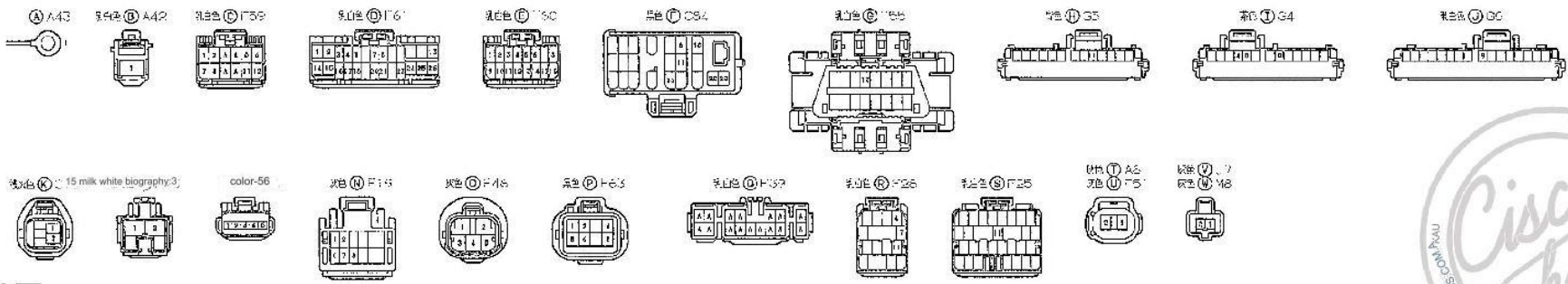
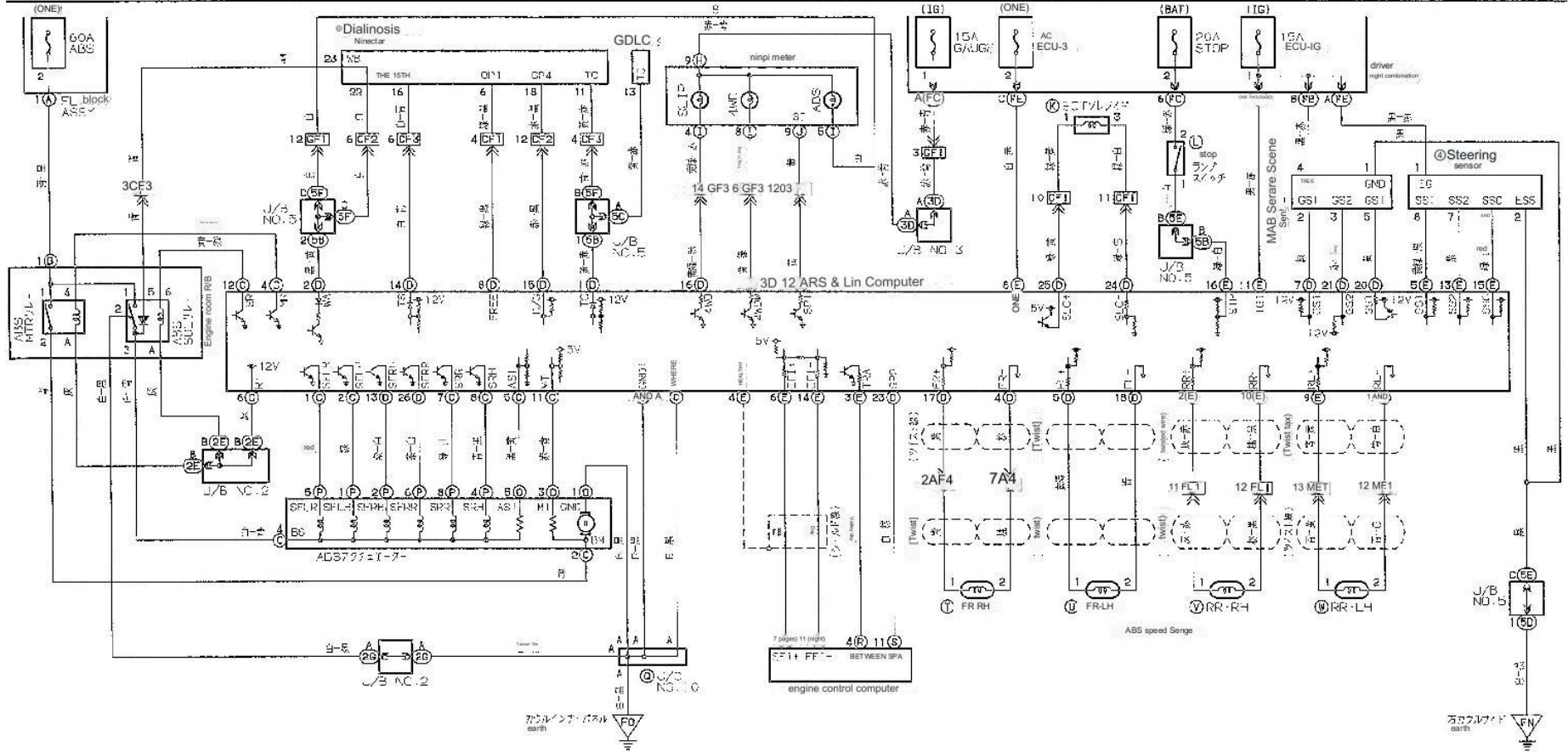

ABS & TRC (1JZ-GE)

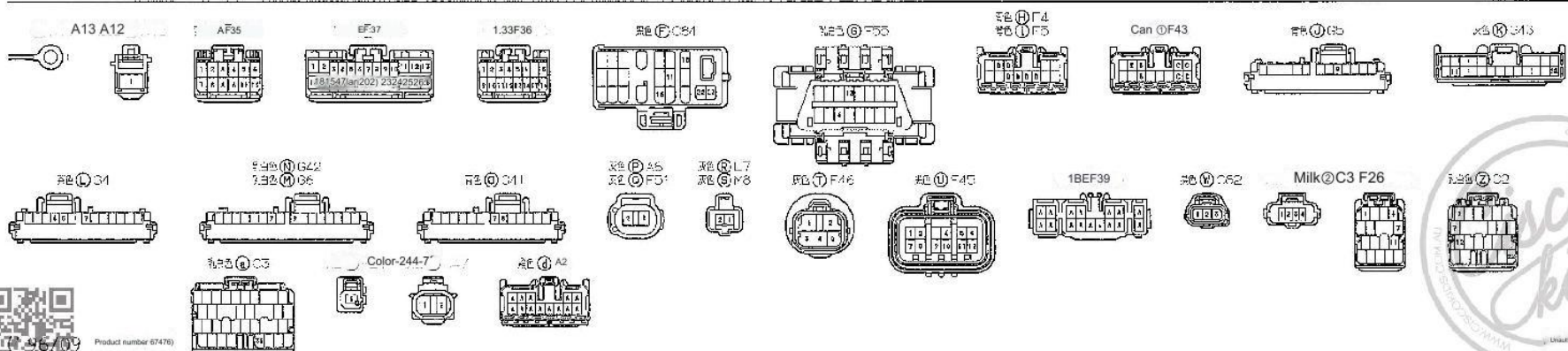
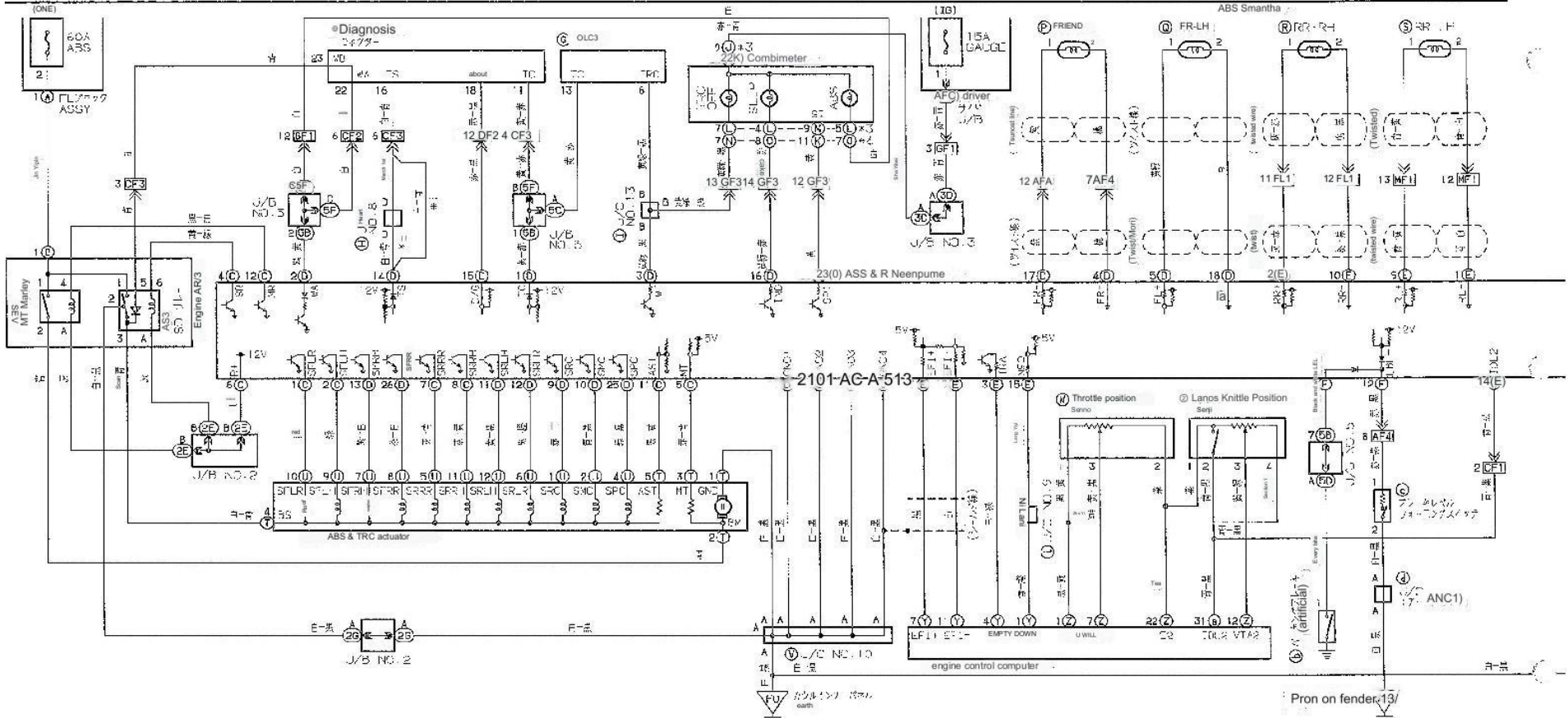

Product number 67476



ABS & TRC (1JZ-GE)

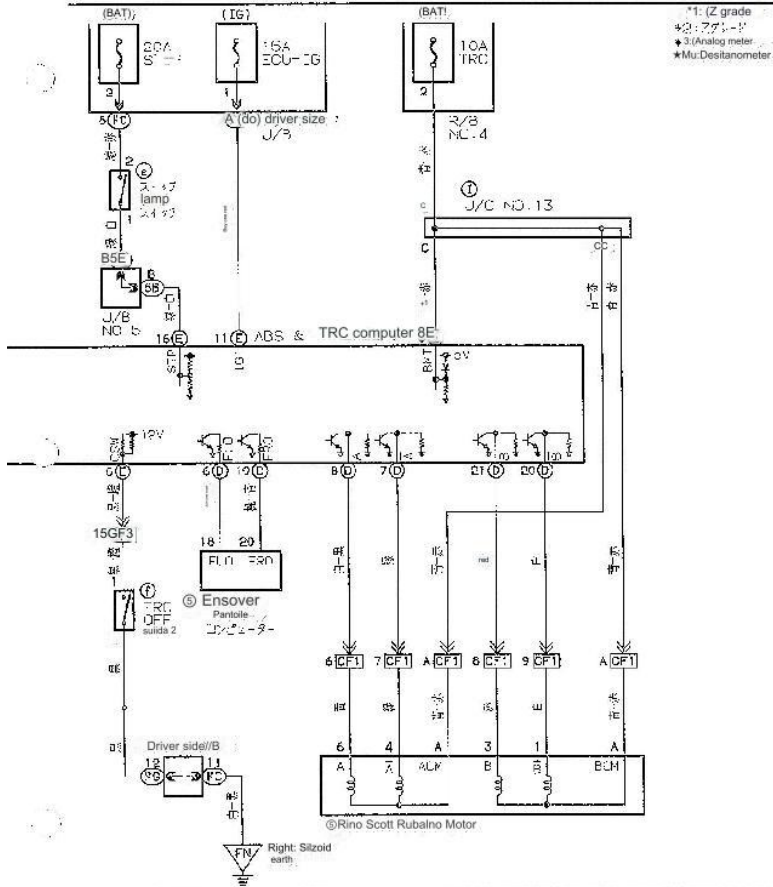

outer mirror

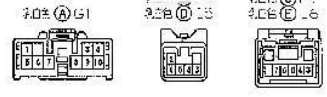
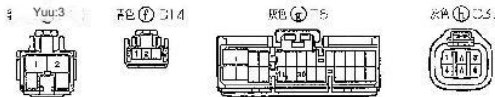
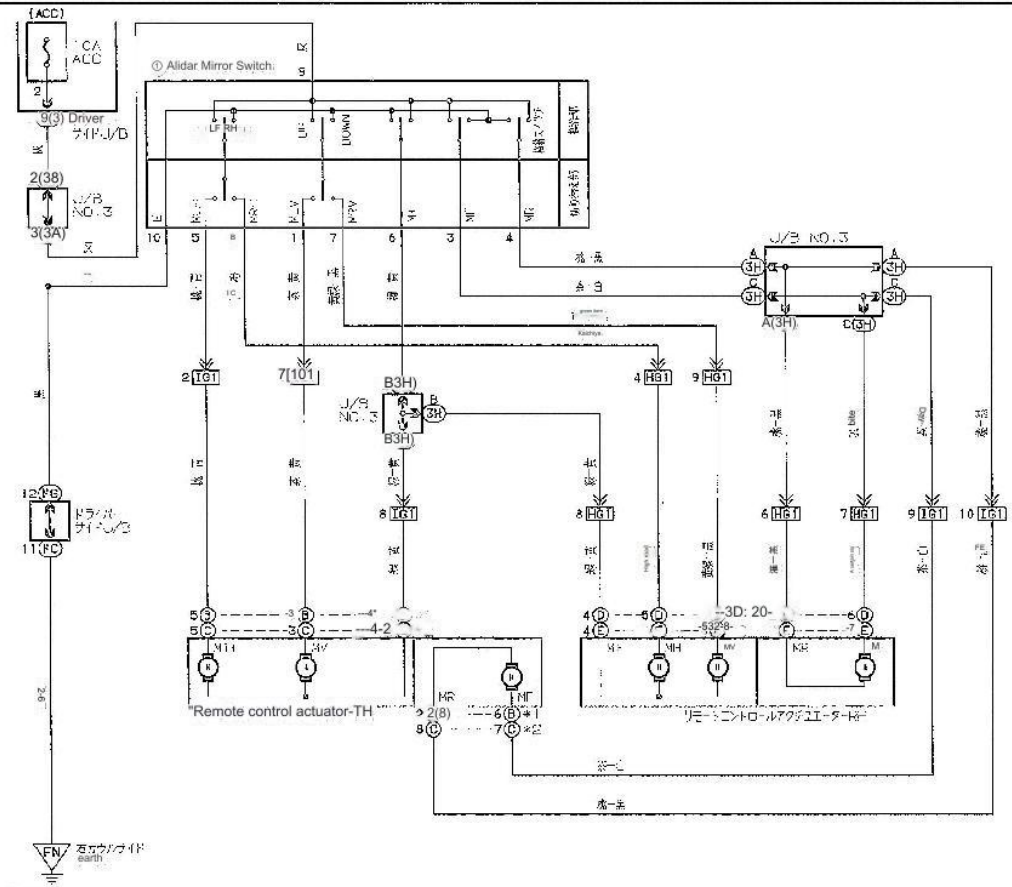

auto air conditioner

*1: UZ-GTE 2JZ-CEUN
 *2: Gasoline Noku 3-FE
 *3: JZ-GTE
 *4: Gasoline Noku 3-FE
 *5: 2L-E
 *6: JZ-GTE 1JZ-GTE
 *7: 2UZ-CE Gasoline
 *8: VA-1: Akkolimator
 *9: V9C
 *10: Digital Meta
 *11: 3JZ-GTE
 *12: JZ-GTE 2L-TT

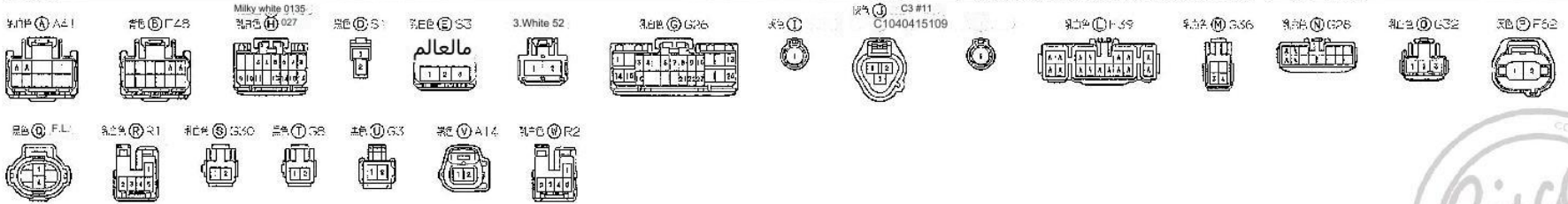
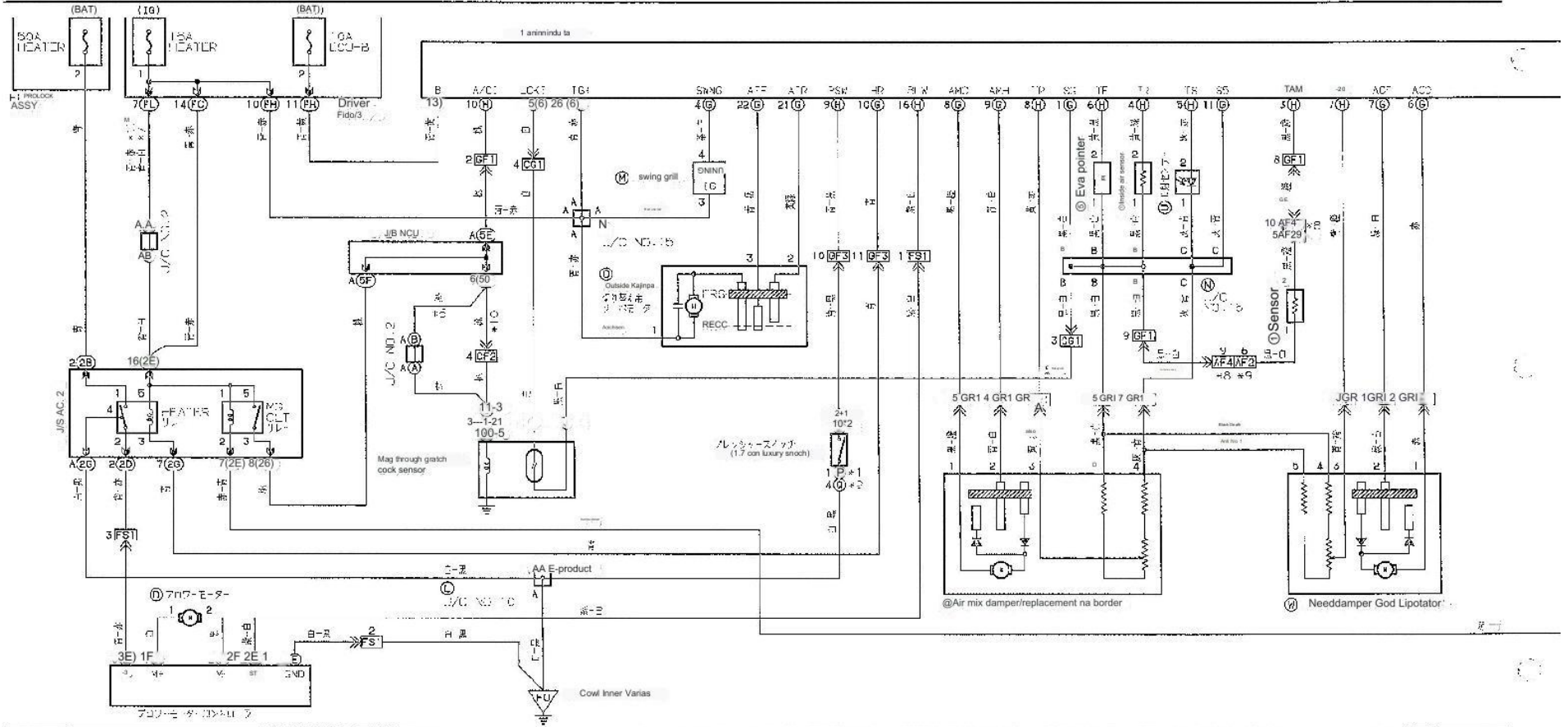

Product number 67476



auto air conditioner

7.2JZ-GE
13J17-3TR
*6: 1JZ-GE, 1JZ-GTE, 1JZ-GE, 1JZ-GTE
*14: 1JZ-GE, 1JZ-GTE

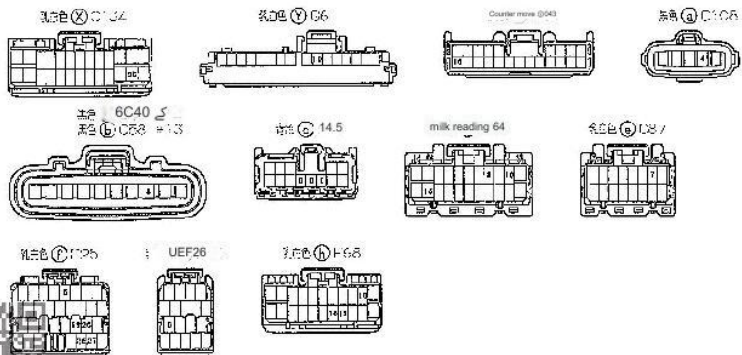
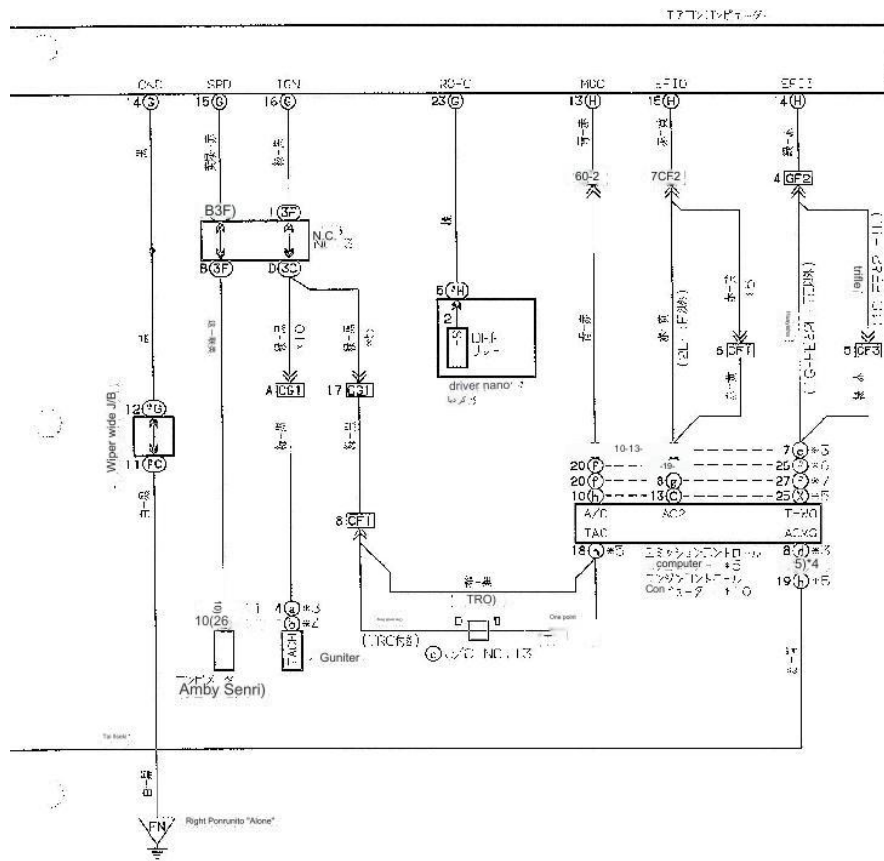

Headlamp (excluding 1JZ-GE S grade and 1JZ-GTE) 3-29

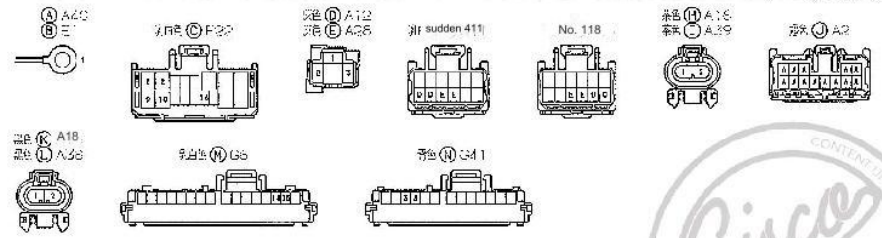
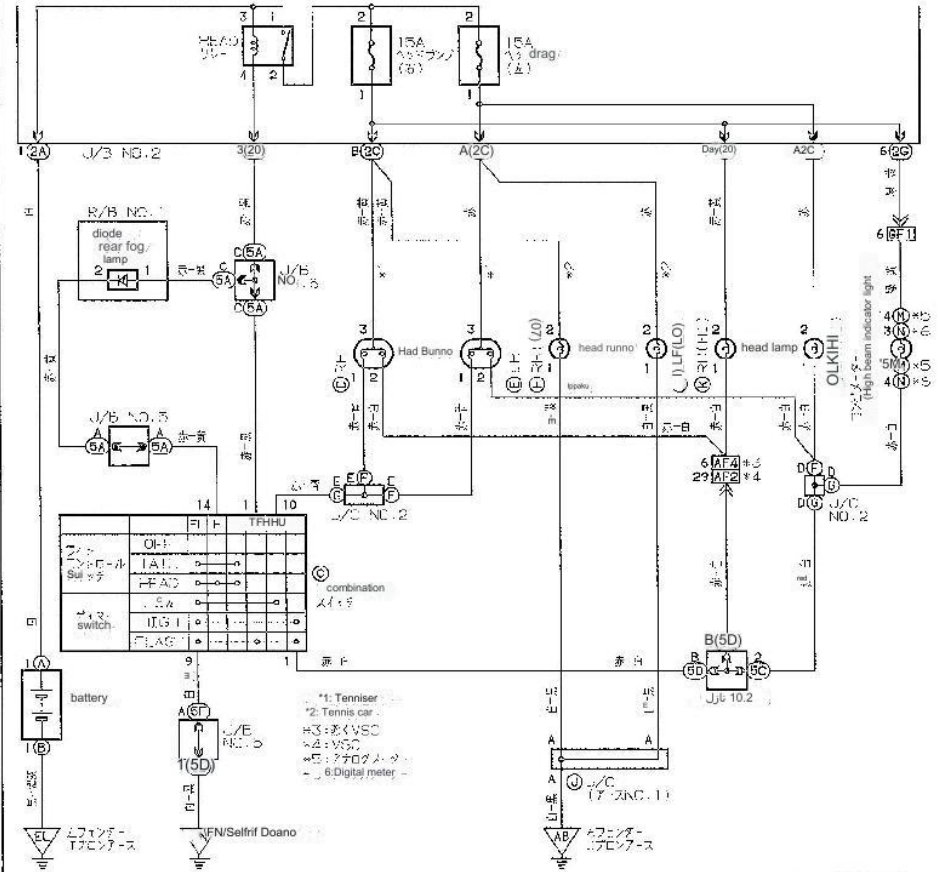

ABS & TRC (diesel)

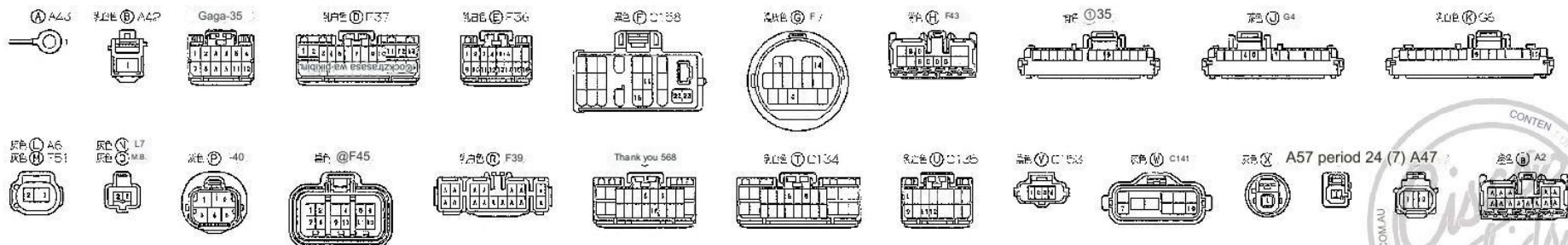
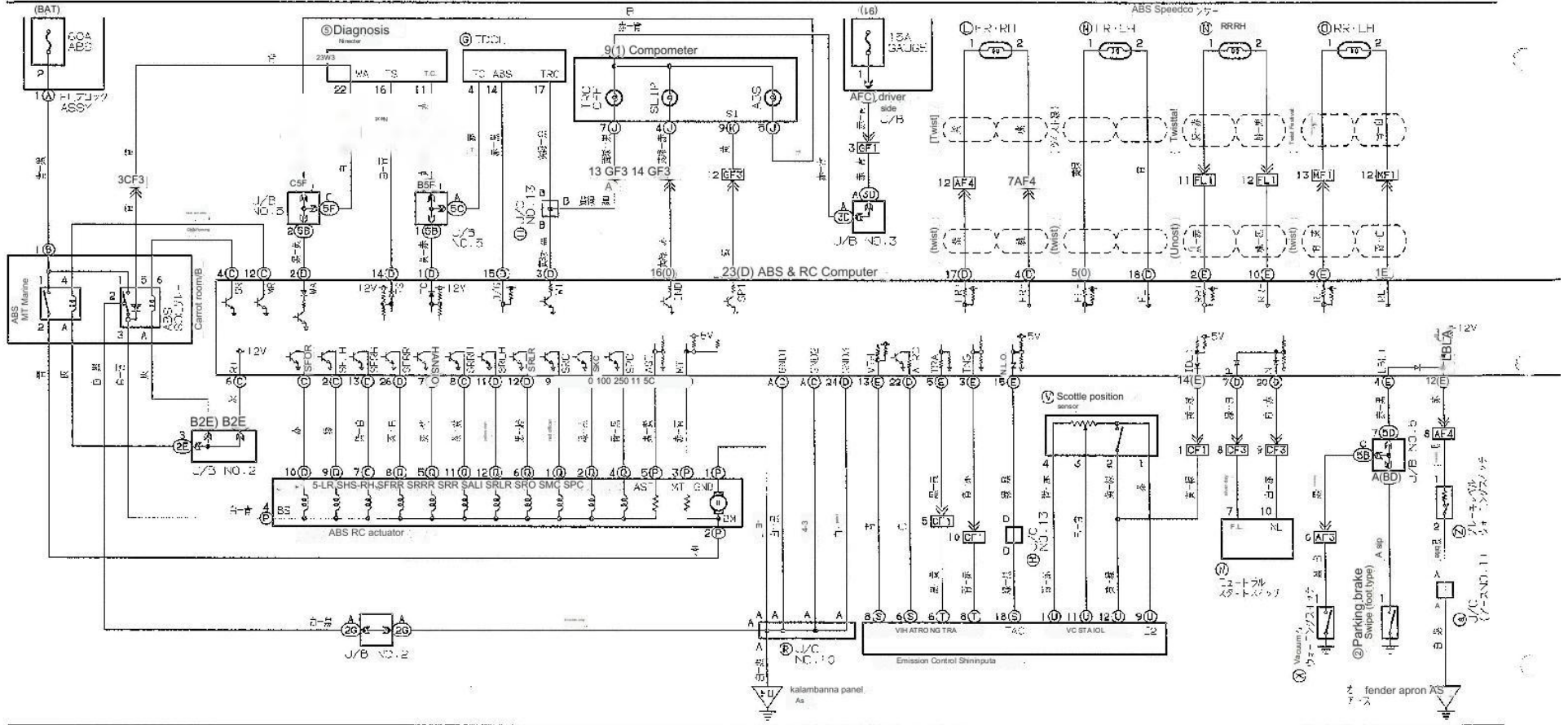

Product number 67476



ABS (VSC)

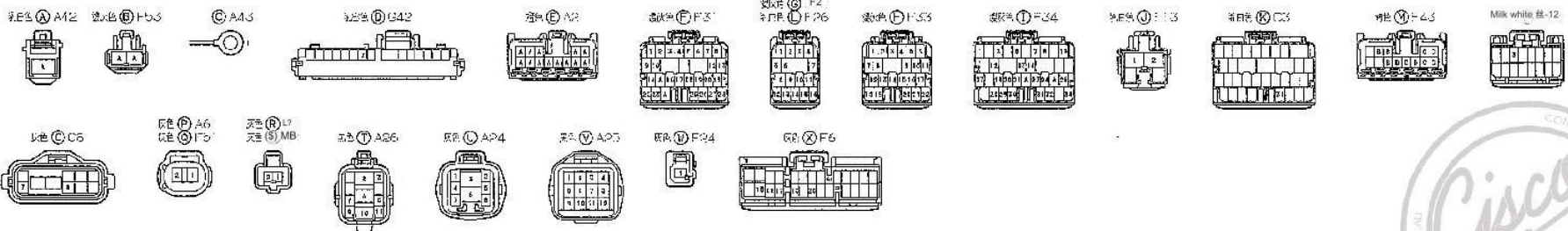
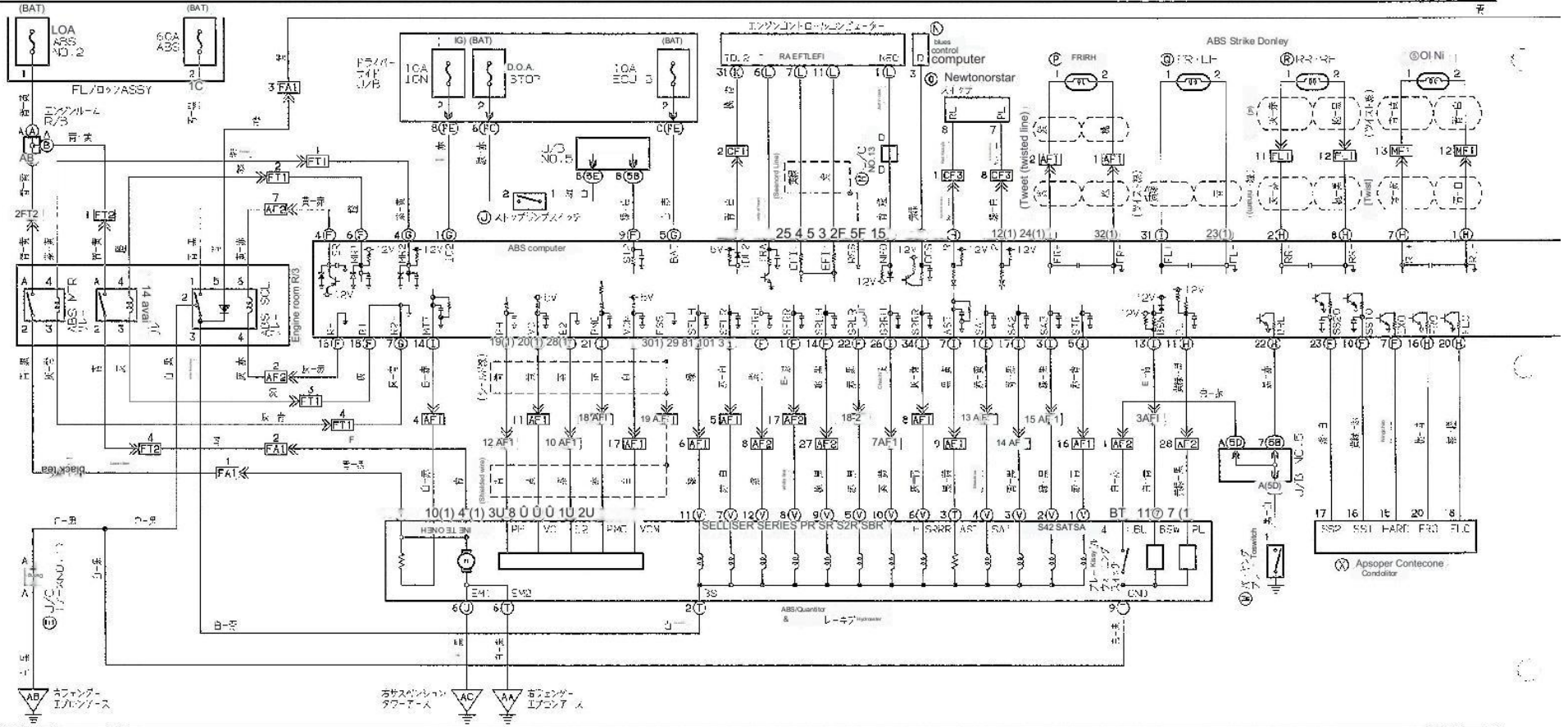

Product number 67476

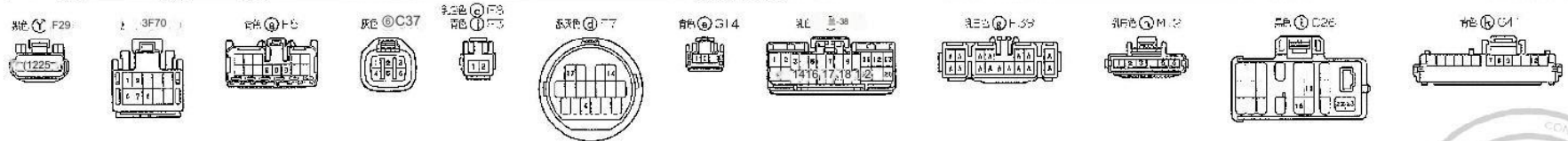
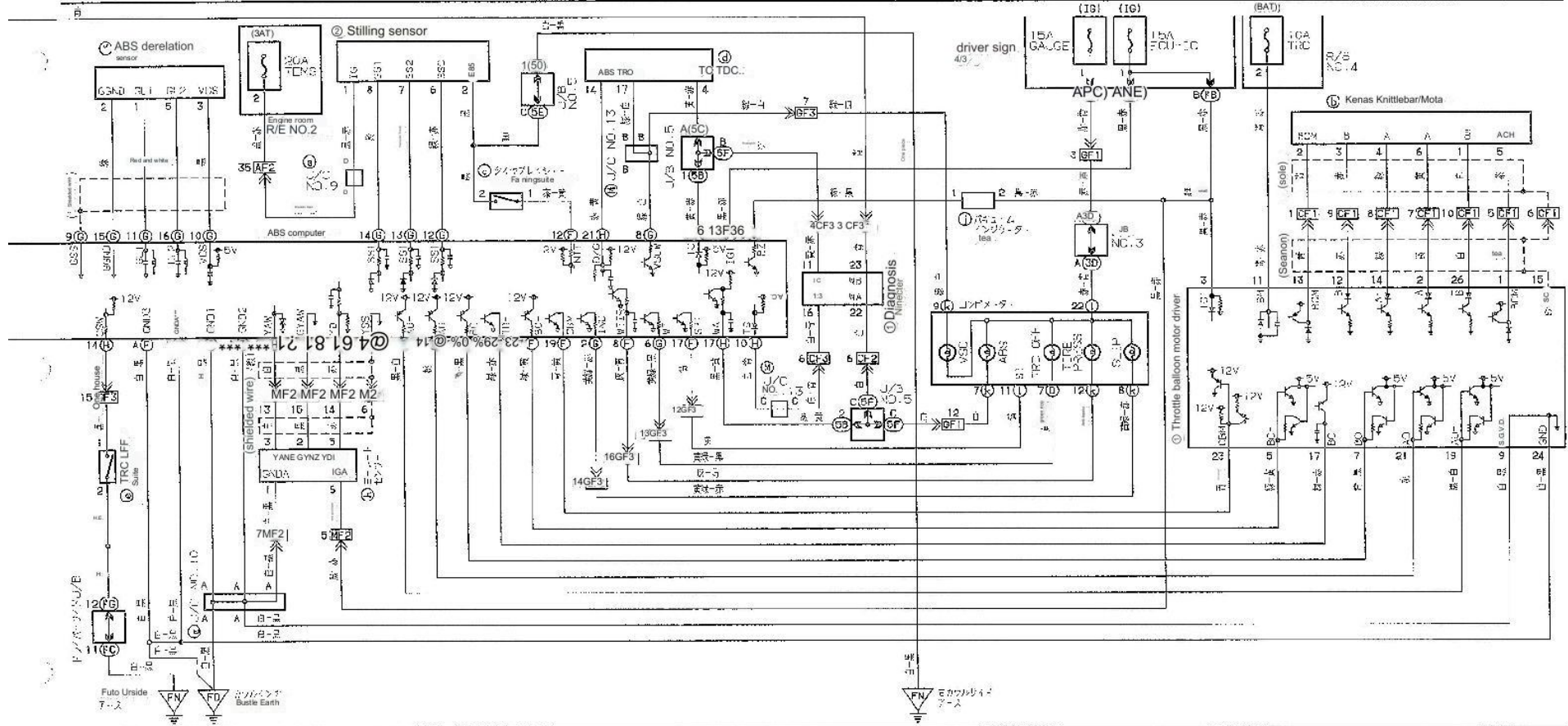

door lock

2: Mark and Denisser without meet-ontion... Cresta La Marconi and Cheyner's mirror heater... heater #fu... building #4: <1G-No Domicia option and Berg Cheyner's mirror... shortpa: Aha Amegoo 45: Digimel Meter

rear window defogger

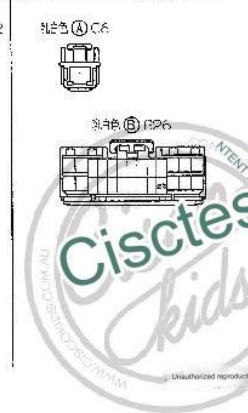
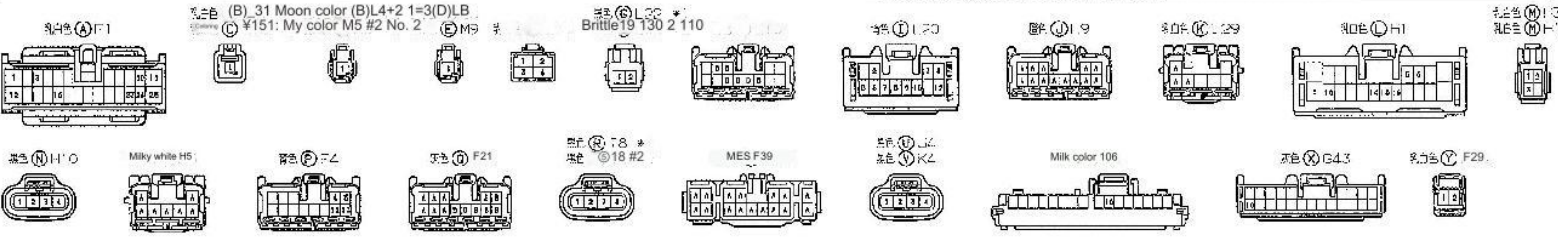
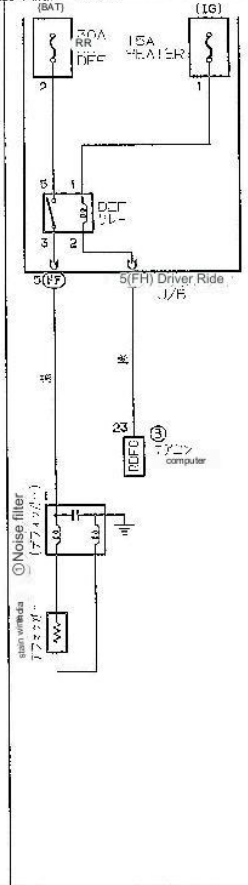
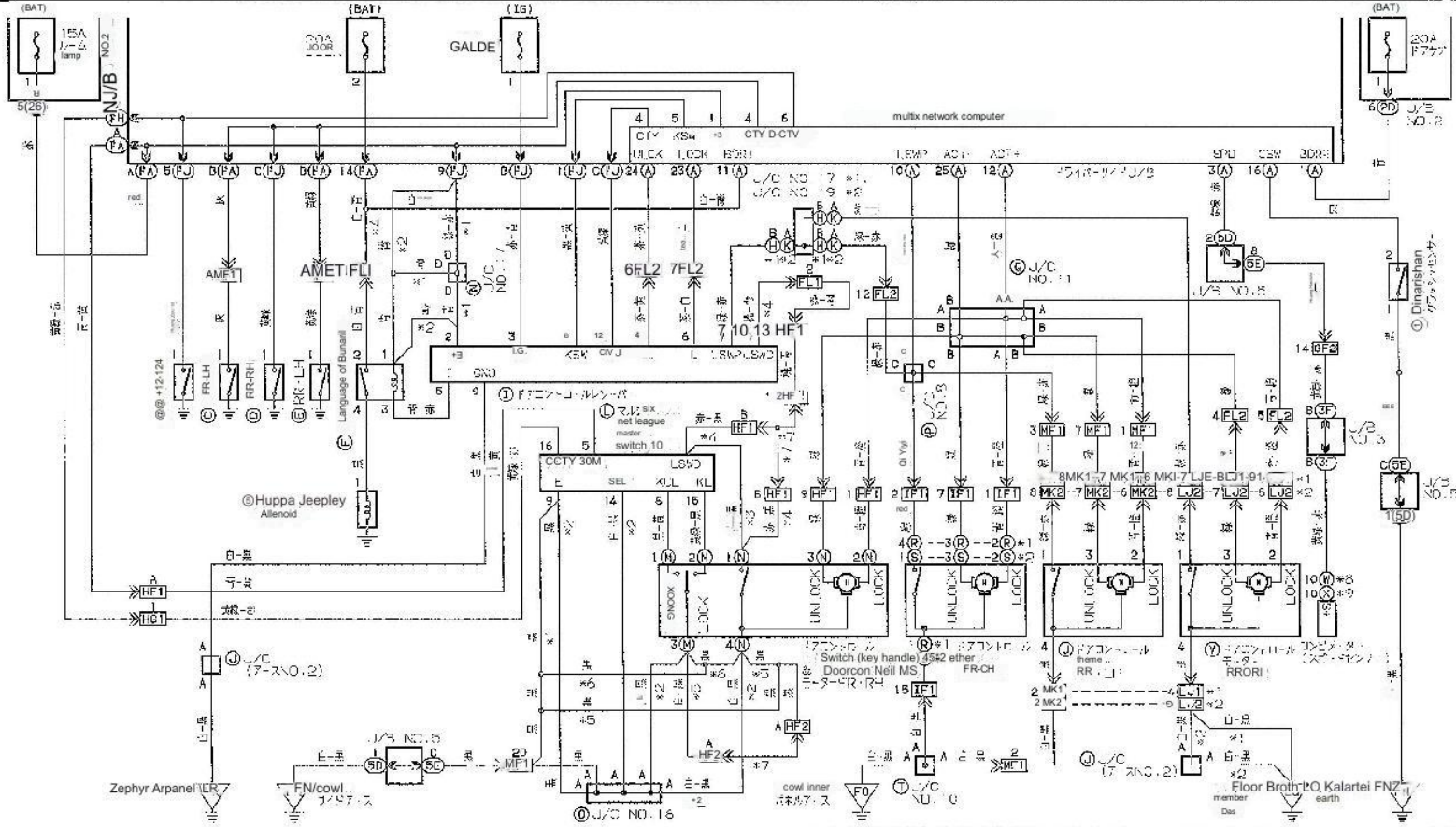

front power seat

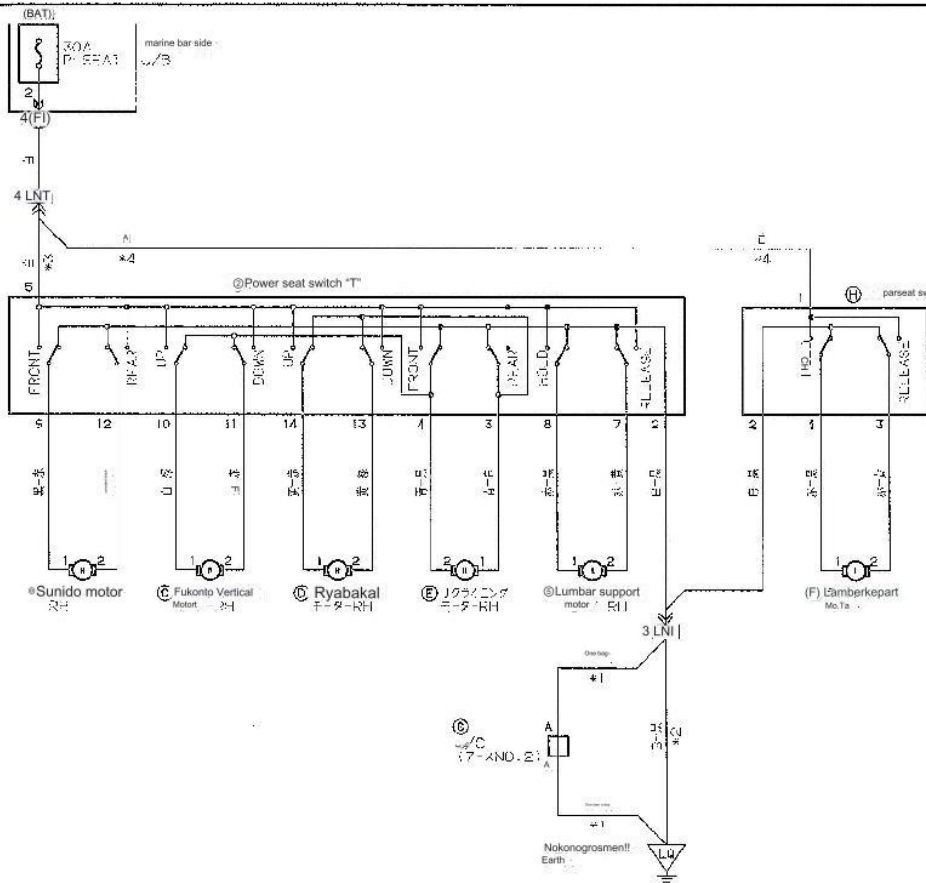

Mark II and Cherry
Gokuto grade
4.4 VAS/L

Rear wiper & washer

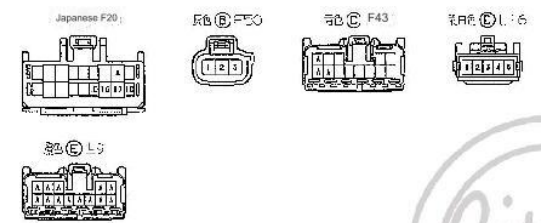
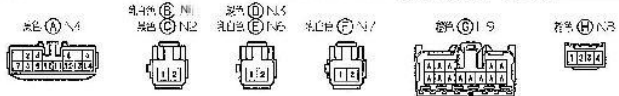
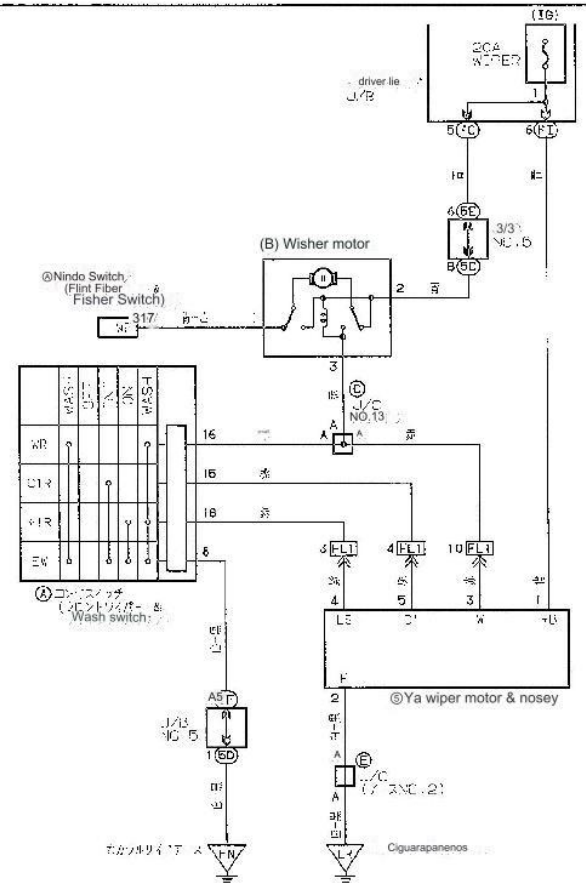

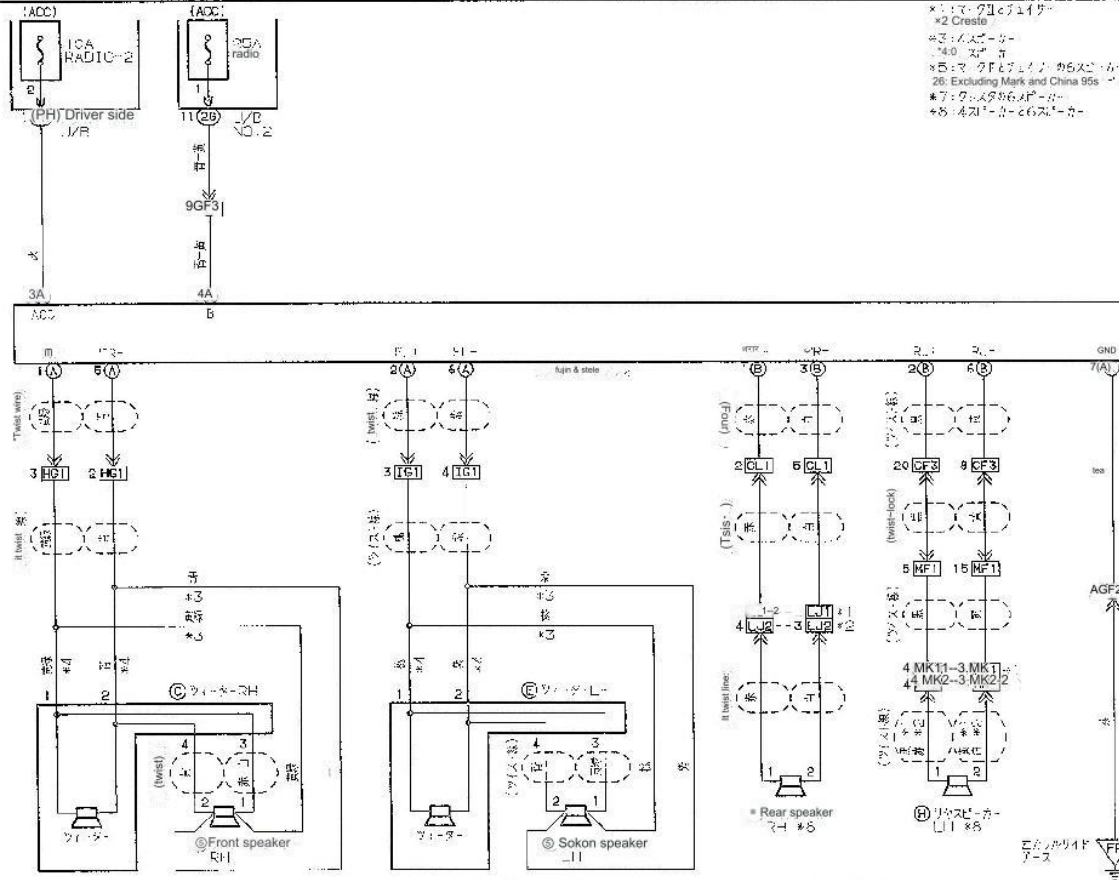

- *1: マーク11
- *2: Creste
- *3: 1.4Z-3-
- *4: 1.4Z-5-
- *5: マーク7
- *6: 1.4Z-3-
- *7: マーク6
- *8: 1.4Z-3-

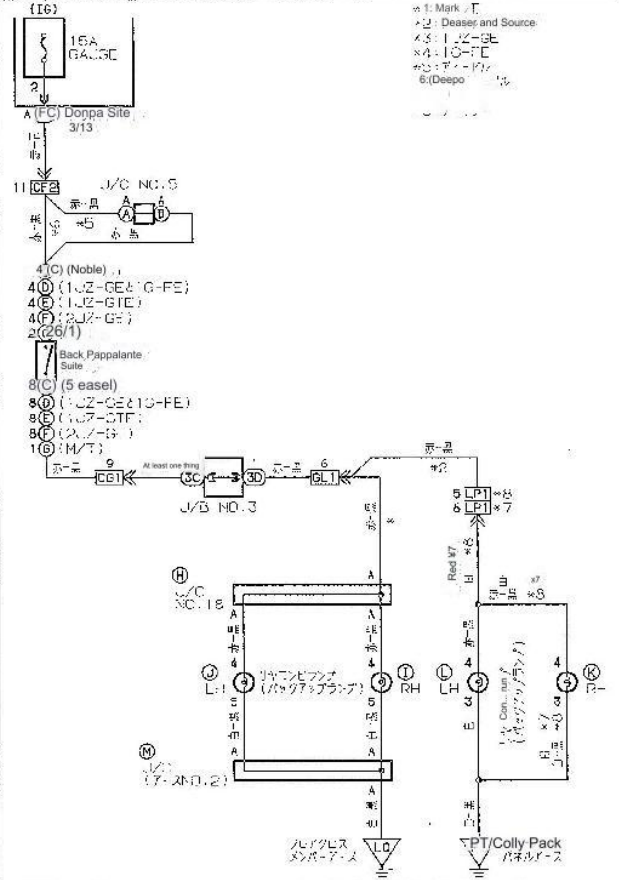

- *1: Mark 11
- *2: Deaser and Source
- *3: 1.4Z-3-
- *4: 1.4Z-5-
- *5: マーク7
- *6: Deapo

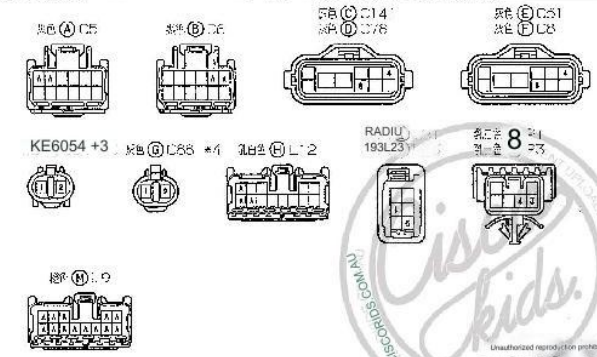
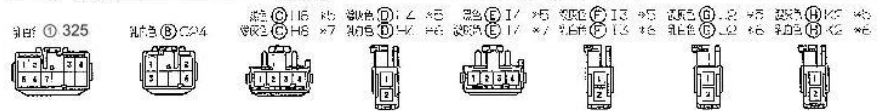

Audio (AV integrated type with built-in amplifier) E

Koryo: Ispeaker

*4: 62D-5-
*5: 10-FE and 1JZDE
*6: 1JZ2-GLE

*7: 2JL-GT
*8: 2L-TC
*The No apption 14:

*10: With avigation
*13: Maji Iwar's speaker
*14: Opening Magna (Ike 26 Speaker La Solesme Speaker 1)

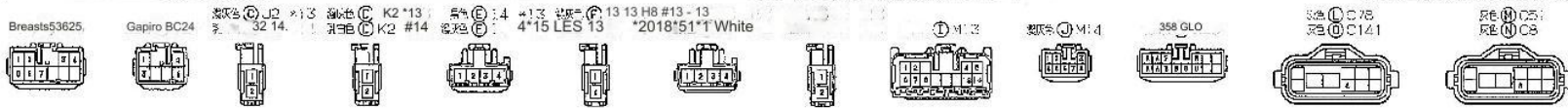
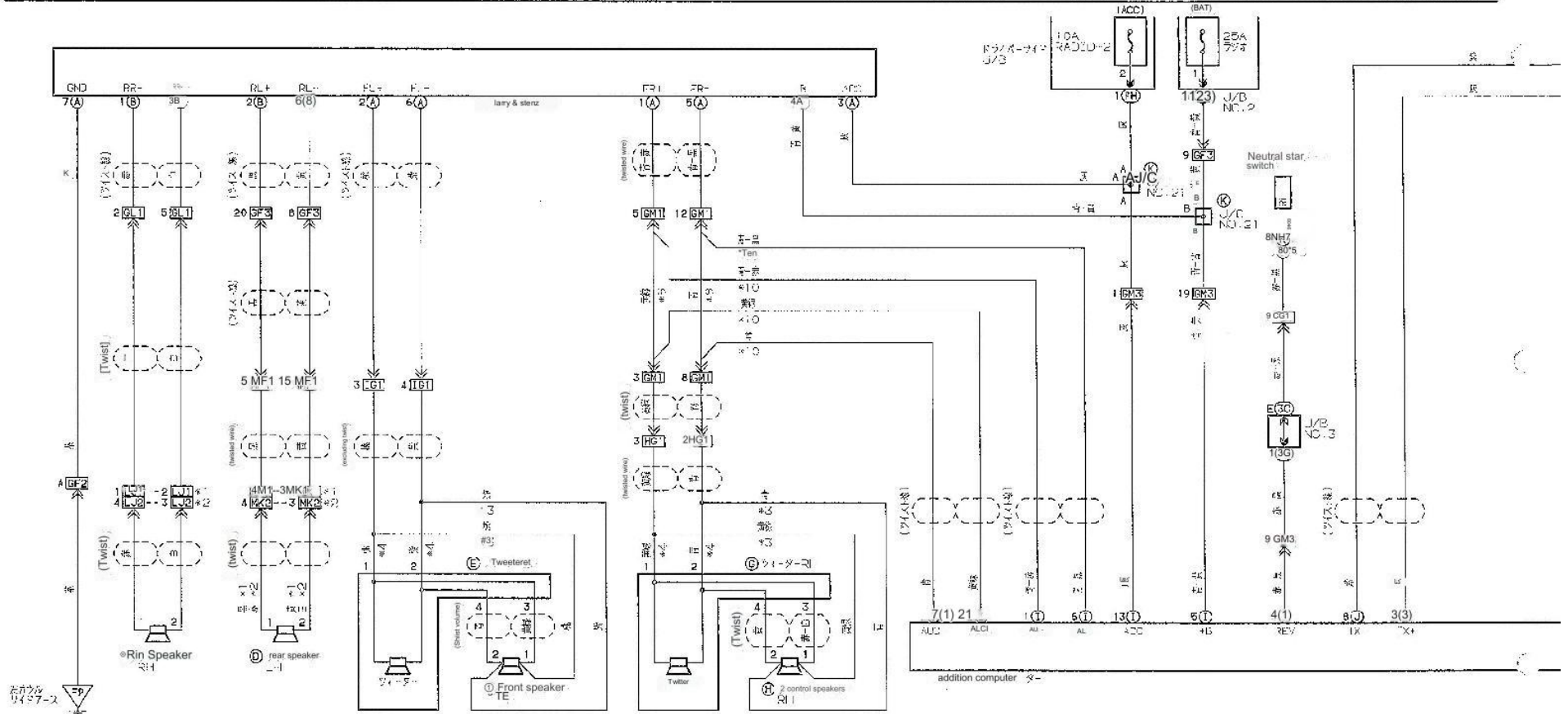

96/09 Product number 67476

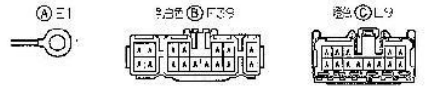
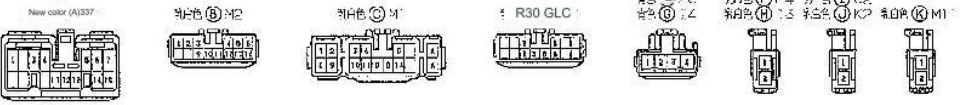
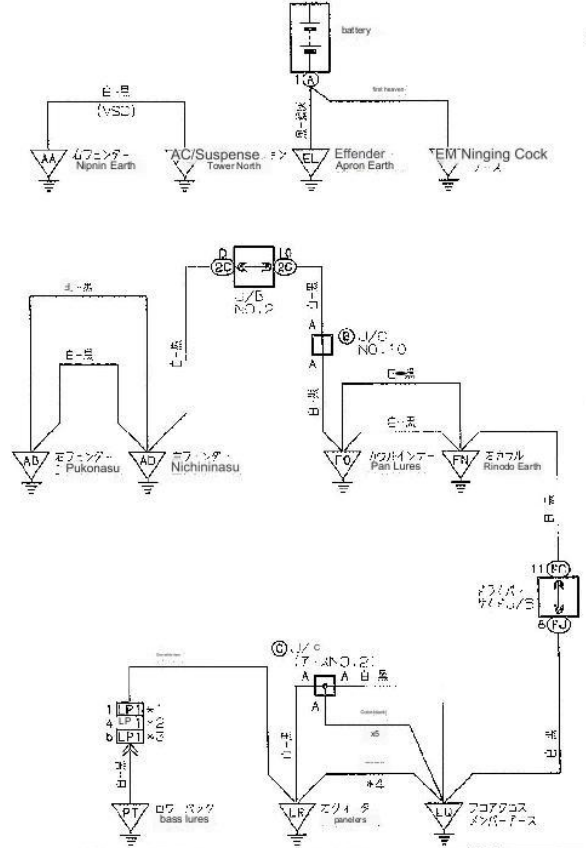
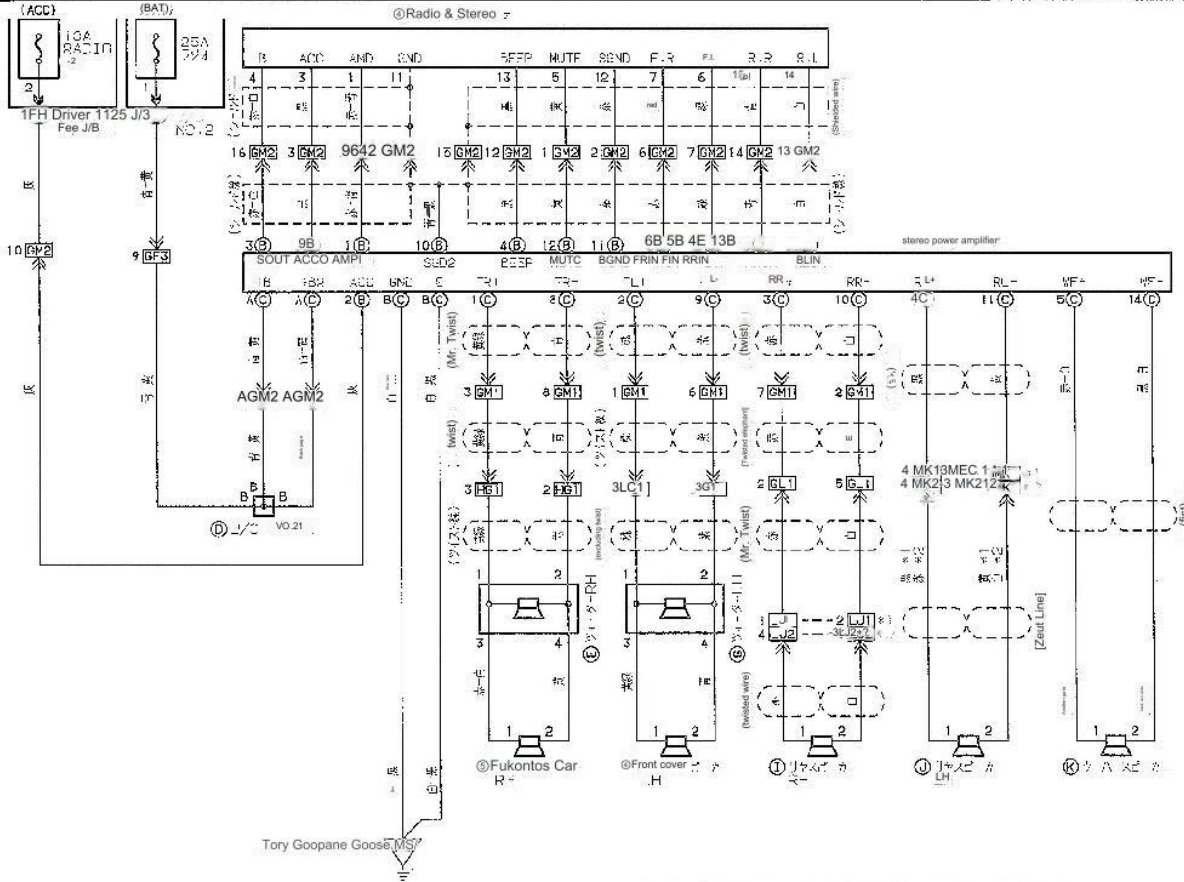

cruise control-

*1: With TRC 407-GE
 *2: VSCH *S: J2-CE
 *3: RCL #5: Analog meter/digital meter

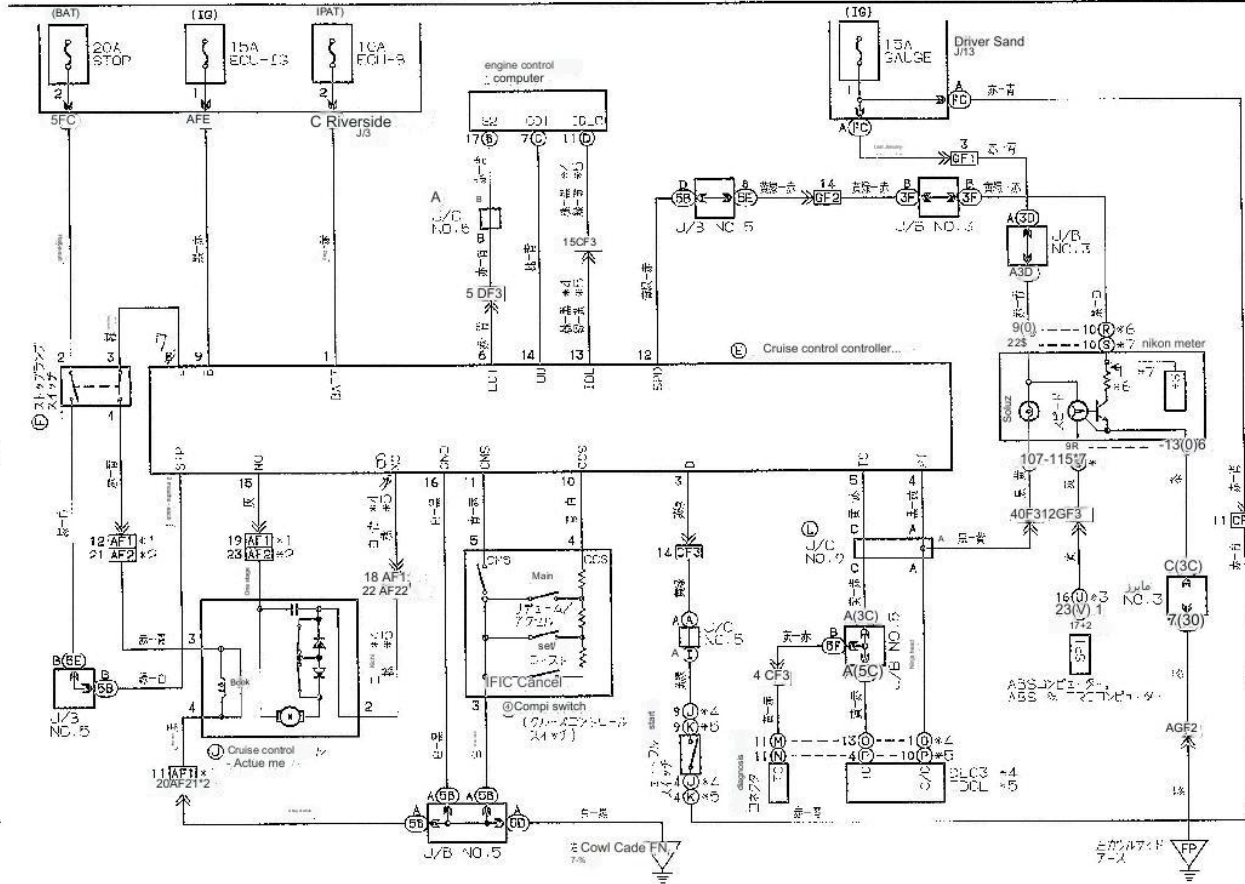

Front wiper & front wiper

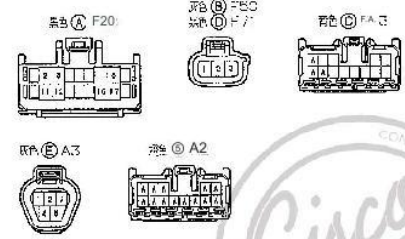
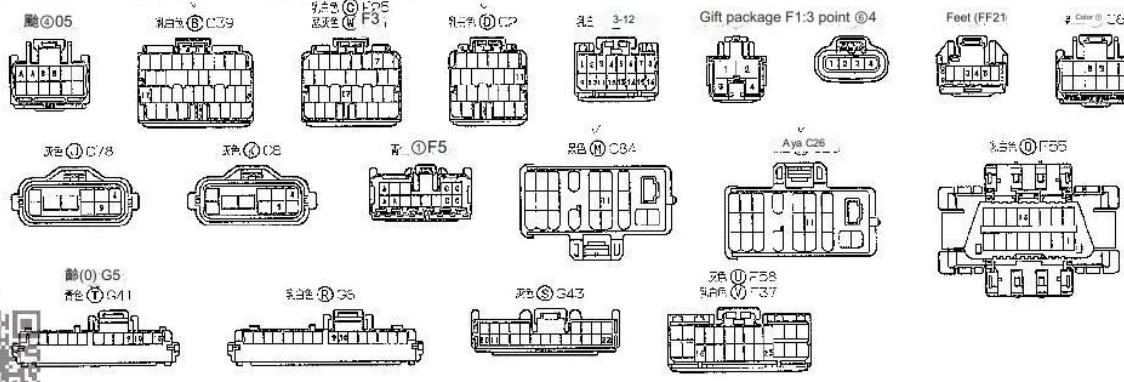
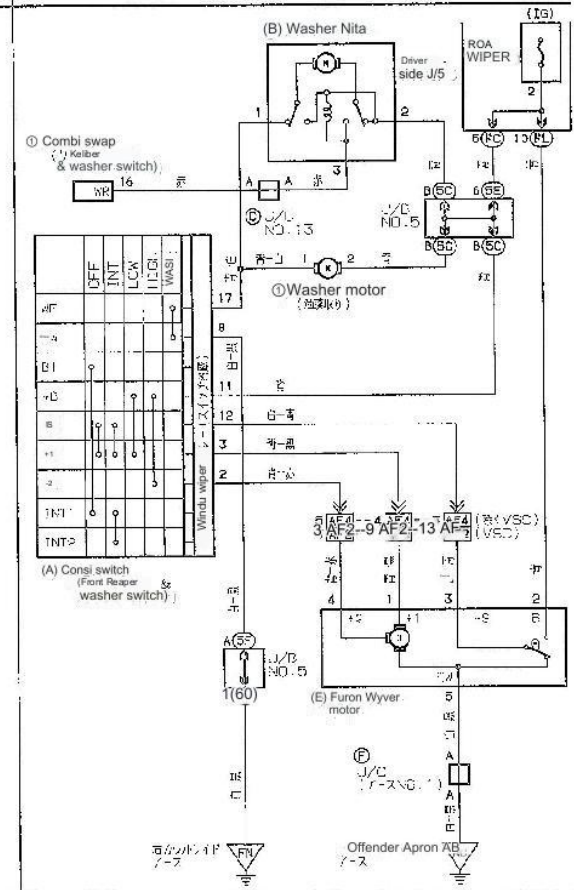

Condonation meter (analog meter)

*1: 1G-FE 20102-0-54/Easel 19.42 *2: 1GZ-SE&1GZ-GTE *3: 1GZ-GTE&1GZ-GTE
 *4: 1GZ-SE&1GZ-GTE *5: 1GZ-GTE *6: 1GZ-GTE
 *7: 1GZ-SE&1GZ-GTE *8: 1GZ-GTE *9: 1GZ-GTE
 *10: TRO216-c-J-0 *11: Gasoline AT11JZ Other than GTE

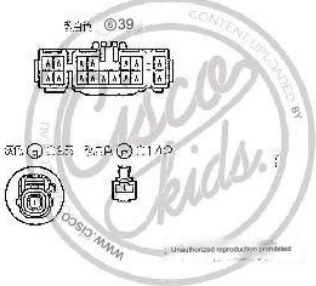
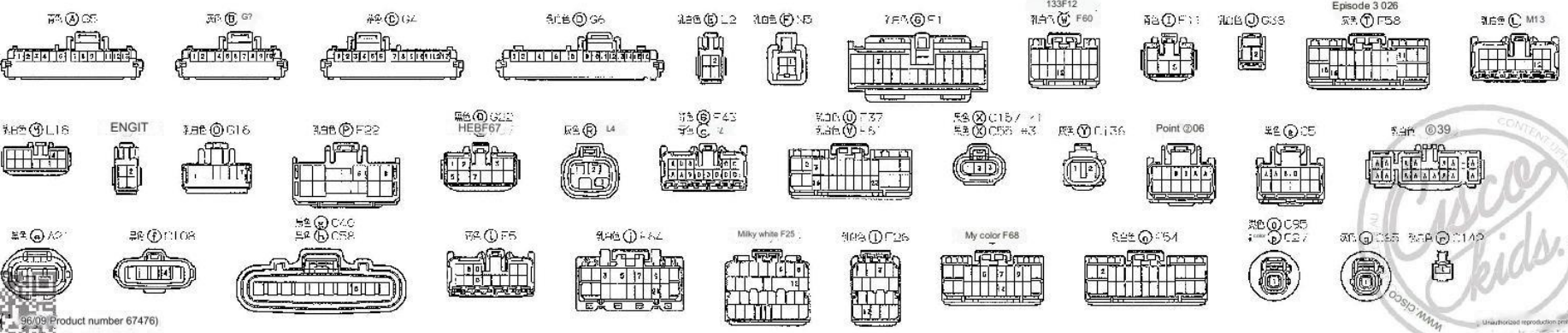
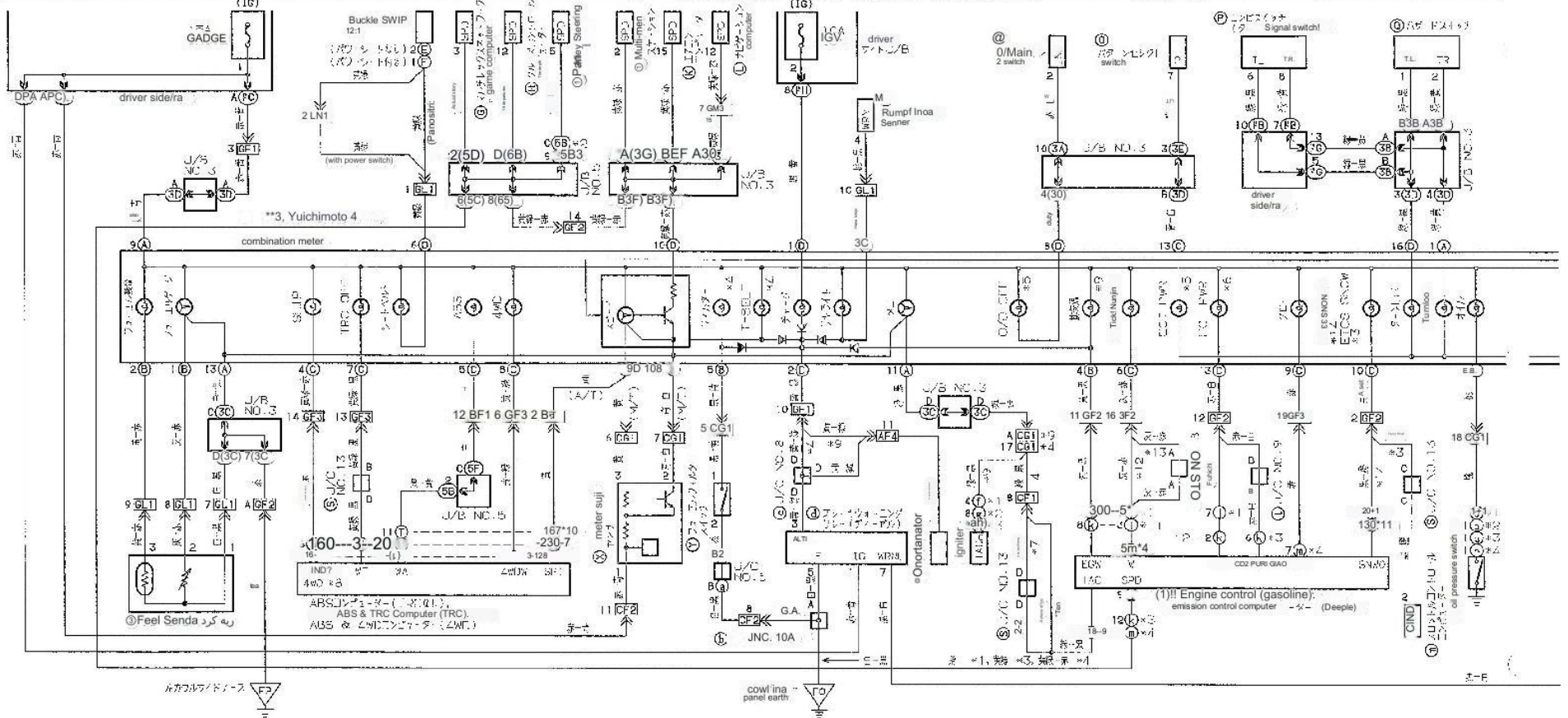

Combination meter (digital meter)

Conlite *1:0FE17 (ECCLE 3-47)

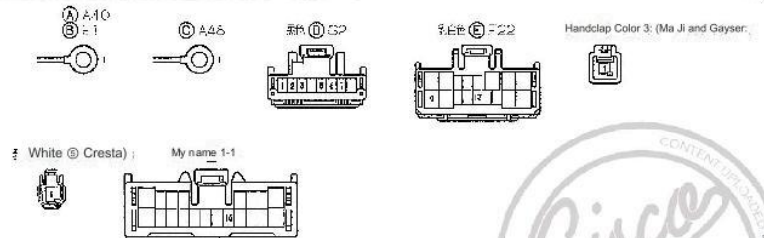
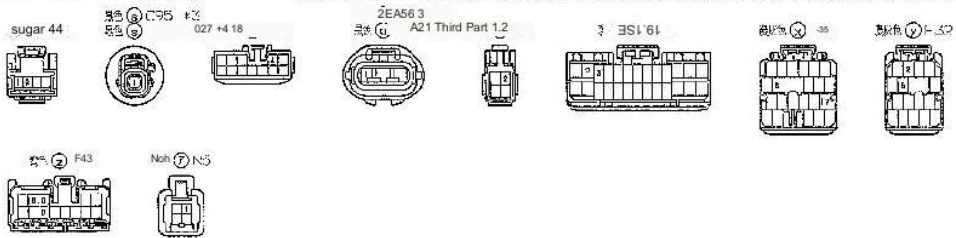
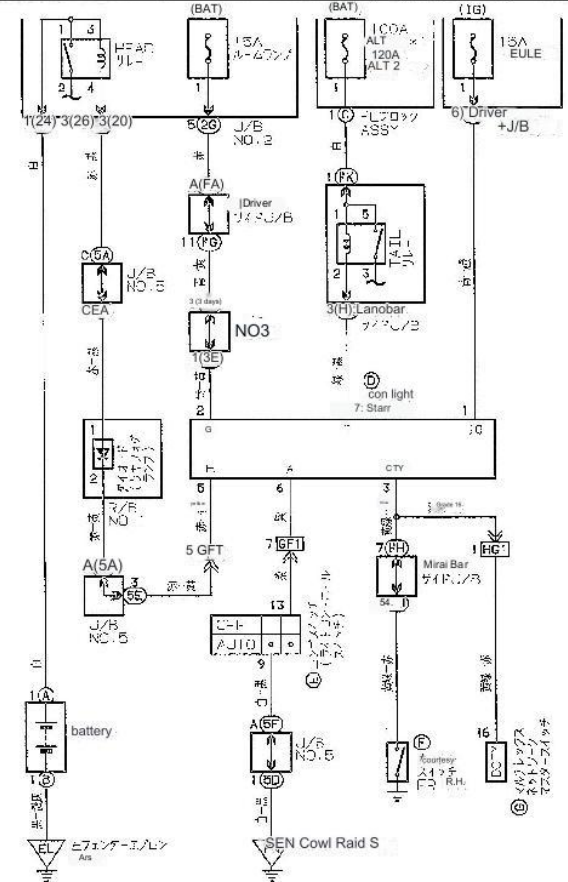
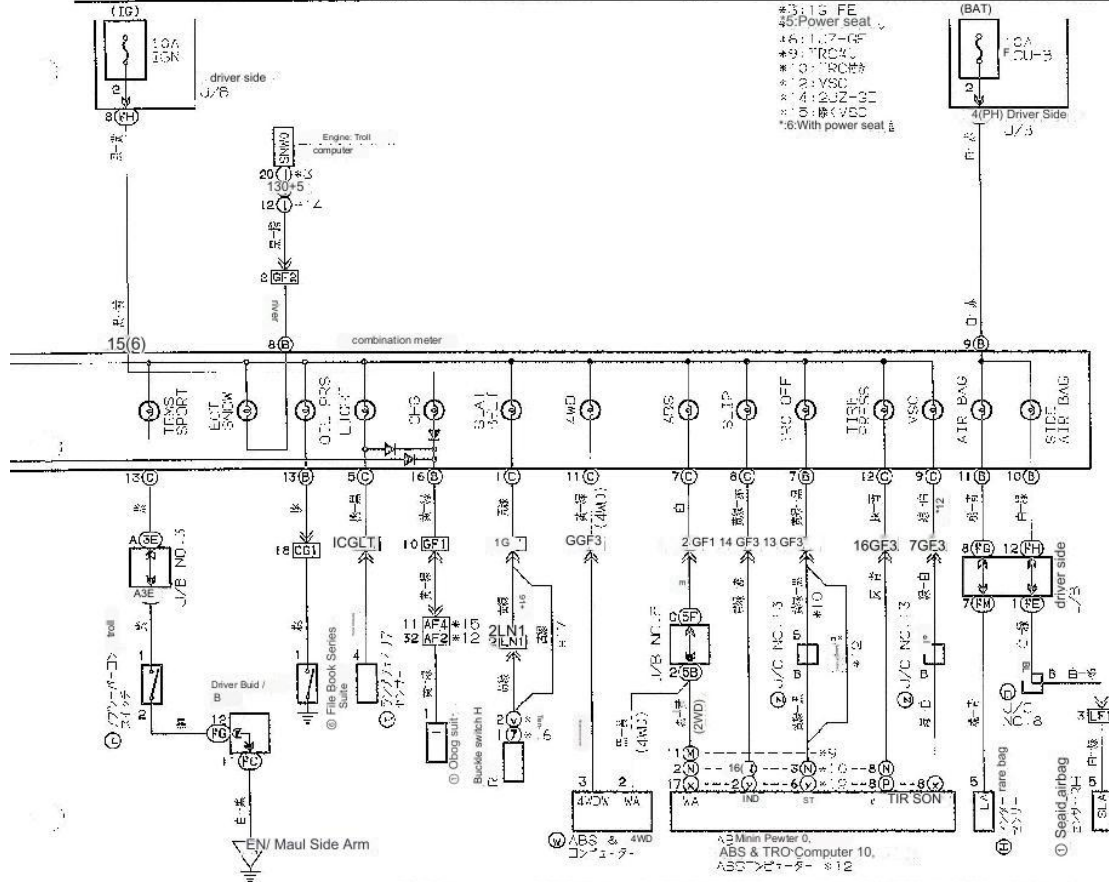

interior lamp

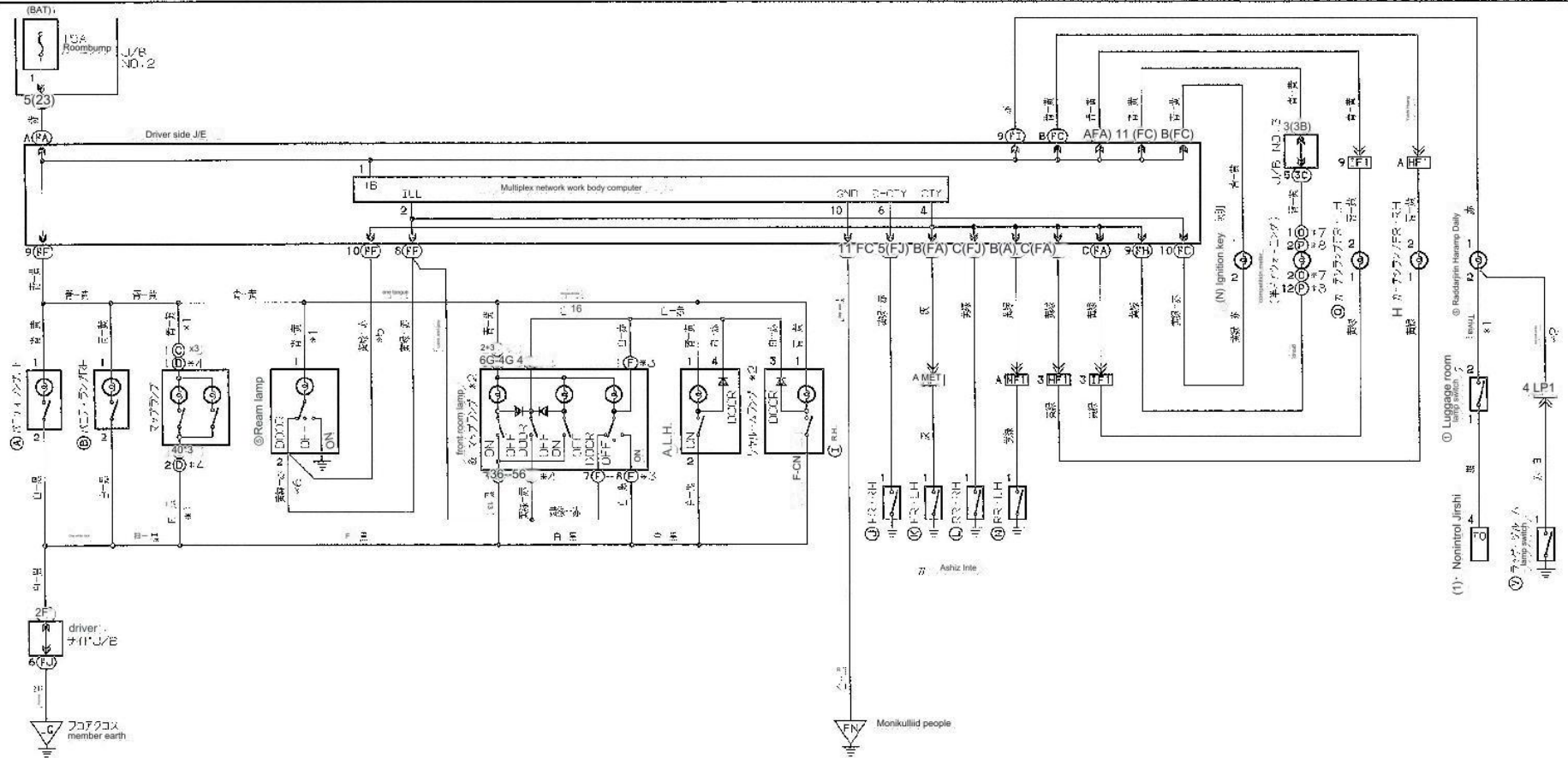

- Color: 107
- ① 01
- ② 05
- ③ 08
- ④ 1010
- ⑤ L31 *
- ⑥ N: G *
- ⑦ M3 *
- ⑧ L4 #2
- ⑨ L2
- ⑩ M9
- ⑪ T-16
- ⑫ G4
- ⑬ G42
- ⑭ 17 milky white 11
- ⑮ 119 s2
- ⑯ L-7
- ⑰ L22 Breasts 19
- ⑱ P4



fog lamp

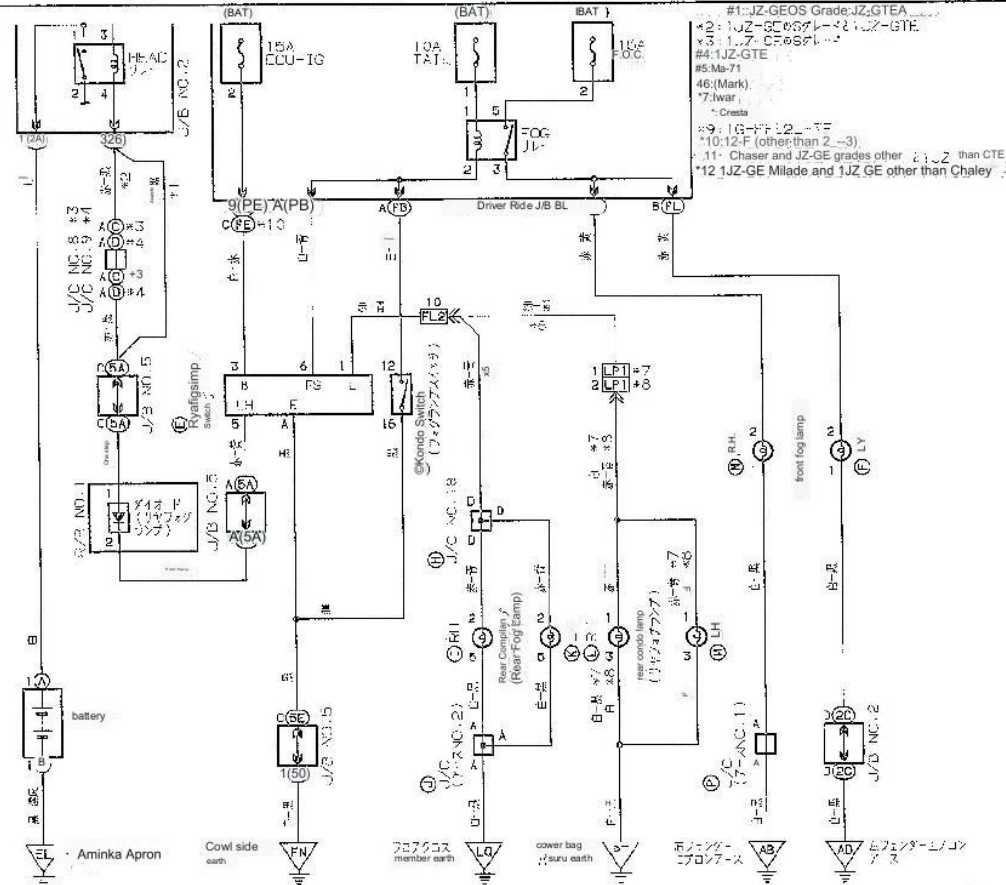

Turn signals & hazards

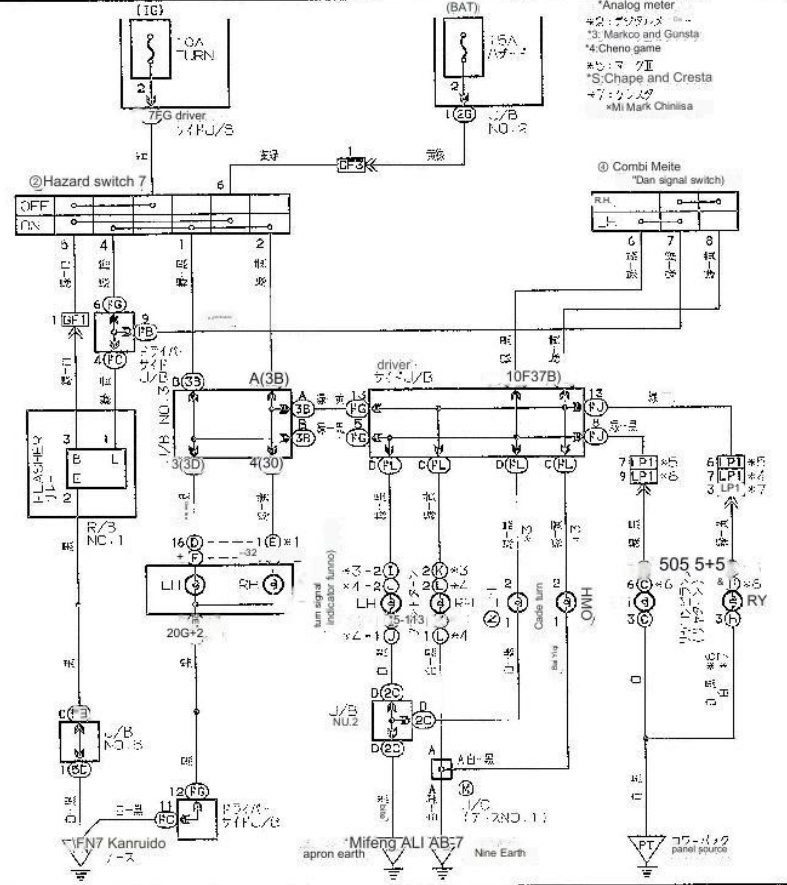

- A4C
- C1
- 4
- 4
- 4
- A35 *7
- A52 *12
- F22
- White L-12
- L21
- L23
- L9
- L2
- P3
- P1
- A10 S11
- A31 S1145-12
- NA19 *7

- Story 322
- F22
- Color 023
- LAE P1322
- C5
- REG43
- A32
- A35
- A3
- A15
- A2
- A34
- A7



fuse-load

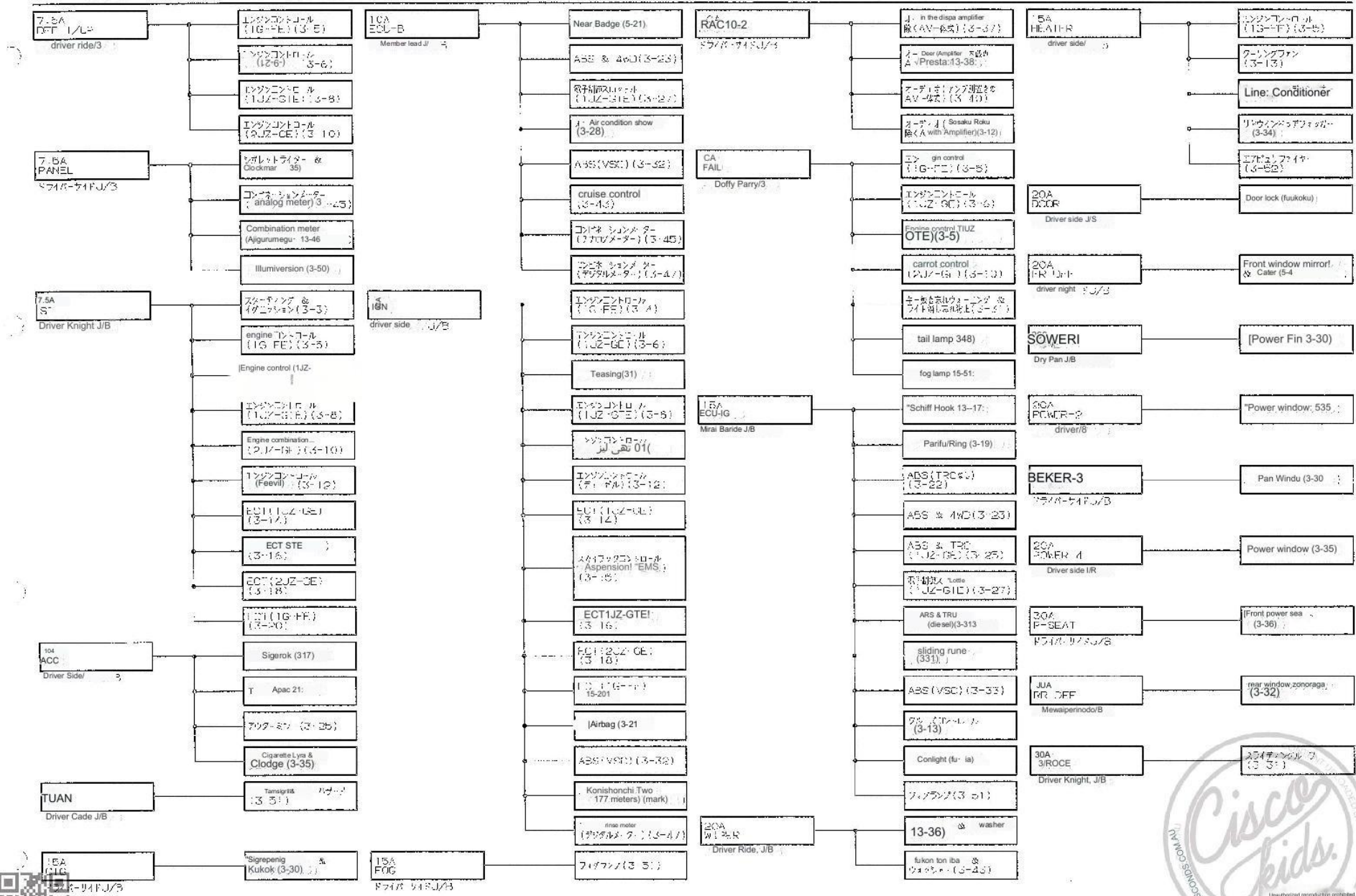

The order of food entry is different from the actual connection order.



fuse-load

*1: Excluding 1J7-CF's Dard and JZ-GTE *3:
Sorin *2: 1-GES/Seed and JZ-

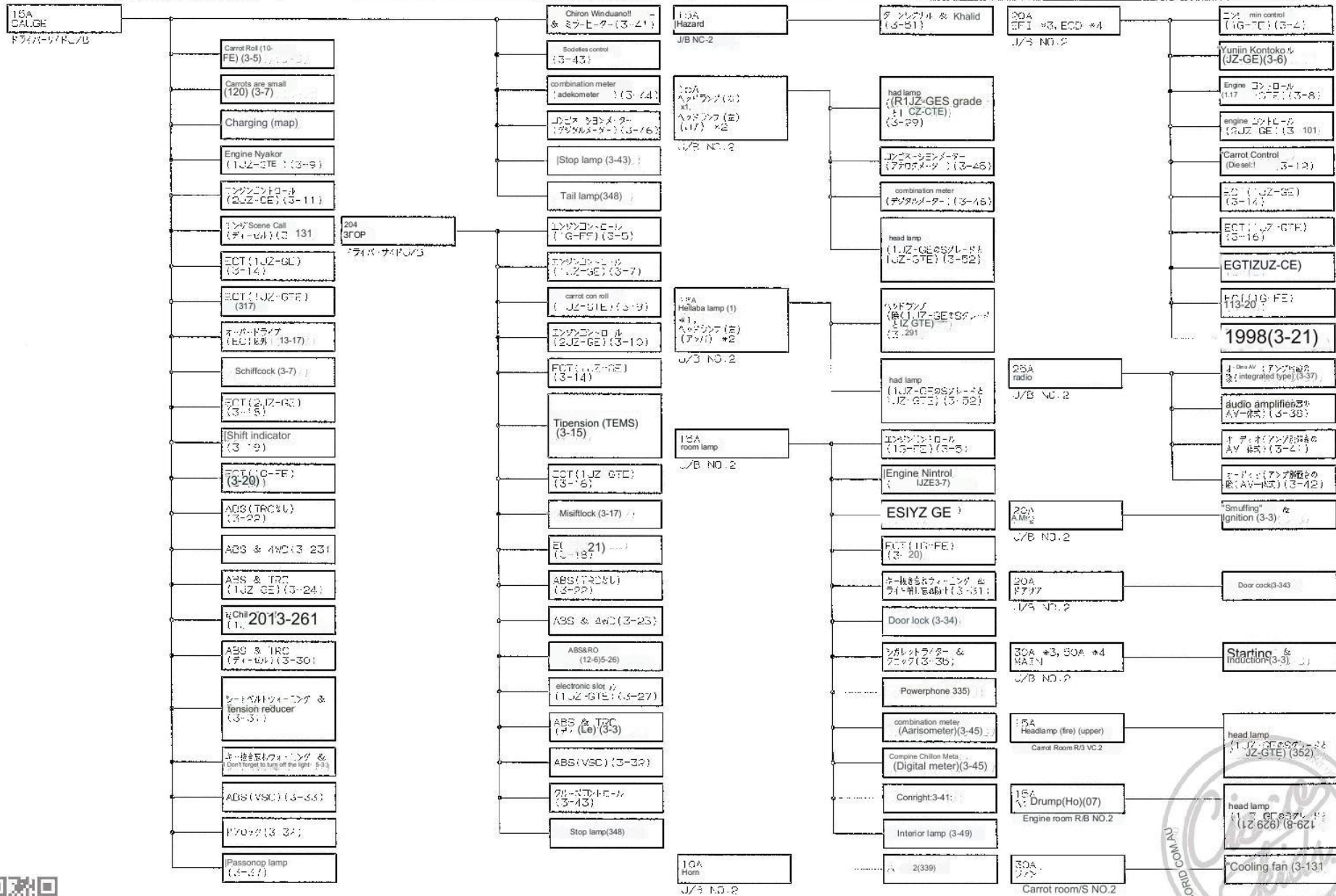

Product number 67476

*The load description order differs from the actual connection order.

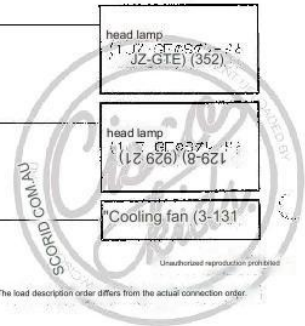

Earth one load

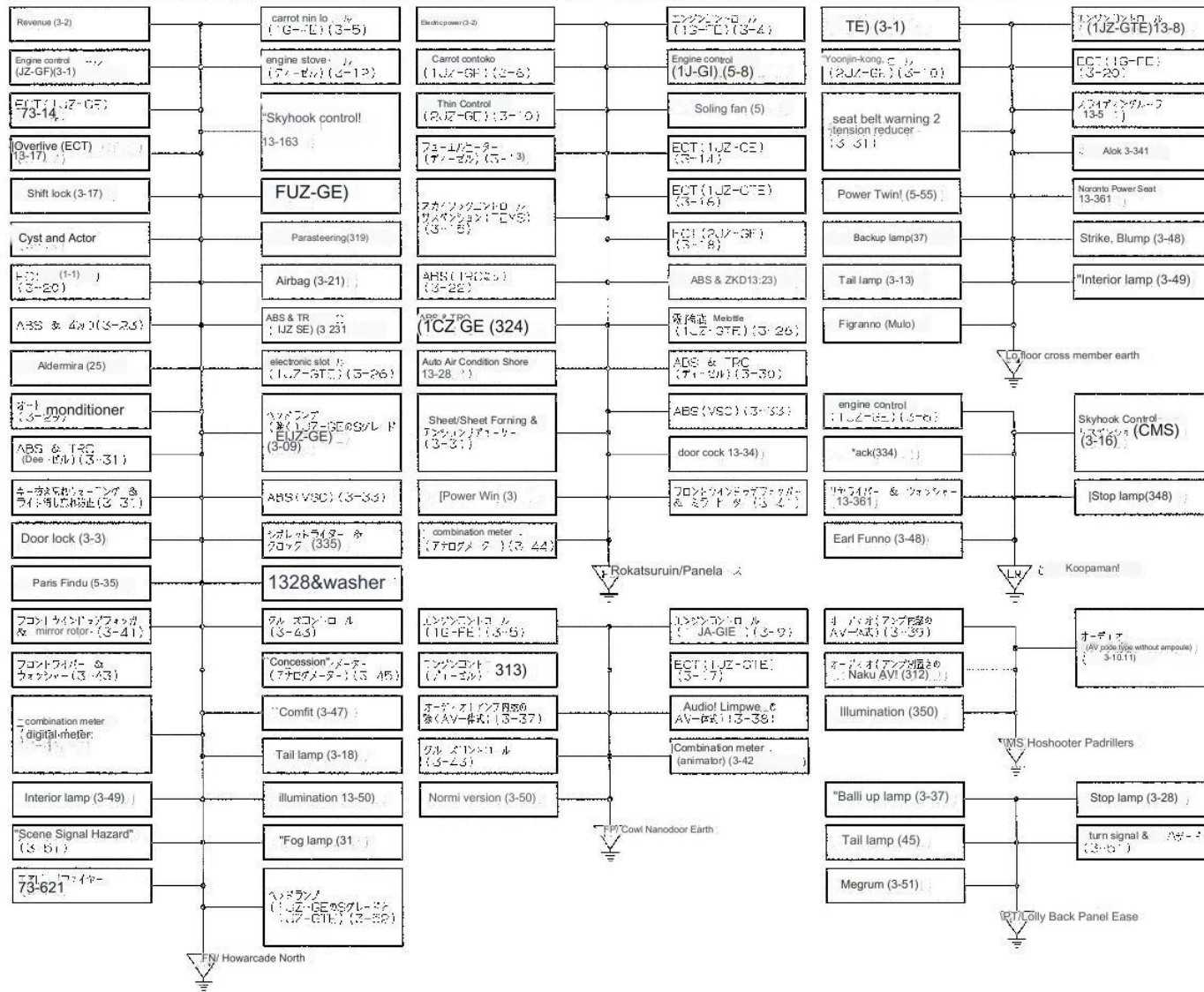

Product number 67476



The load description version is different from the actual connection request version.